









Inspired by efficiency

Applying protective covers to cables and wiring can be time consuming – removing them for maintenance or modifications even more so. Reduction in the time needed to remove and reapply cable covers inspired us to develop Helawrap. This flexible cable-bundling solution is quick and easy to apply with a simple zipper-like action. Specially designed gaps in the overlapping cover mean installers can safely branch off cables at any point. Whether used in the office, factory, wind or solar installations, we ensure that all our cable protection solutions score highly on their usability and quality – and maximum efficiency.



	3.1 Non-Metallic Conduit Systems	312
	3.2 Metallic Conduit Systems	318
	3.3 Spiral-Reinforced Conduit Systems	326
	3.4 Conduit System Accessories.....	332
	3.5 Protective Tubing and Spiral Binding.....	334
	3.6 Protective Sleeves	
	Expandable Braided Sleeves.....	348
	Open Woven Sleeves	357
	Burst Protective Sleeves	360
	Electromagnetic Shielding Sleeves.....	361
	3.7 Wiring Ducts.....	364
	3.8 Edge Protection	377
	3.9 Grommets	380





3.1 Non-Metallic Conduit Systems

Non-Metallic Conduits	
HG-SW PA6 Standard	312
HG-LW PA6 Light	313
HG-FR PA6 Flame Retardant	314
HG-DC PA6 Double Slit	315
Fittings for Non-Metallic Conduits	
Fixed external thread	HG-S, Straight, IP66 316
	HG-90, 90° Elbow, IP66 317



3.2 Metallic Conduit Systems

Metallic Conduits	
SC galvanised steel conduit	318
SSC stainless steel conduit	319
Fittings for Metallic Conduits	
SC-FM fixed external thread, IP40	320
Metallic Conduits with Plastic Coating	
PCS, galvanised steel, PVC coating	321
Fittings for Metallic Conduits with Plastic Coating	
PCS-FM fixed external thread, IP54	322
PCS-FMC compression fitting, fixed thread, IP65	323
Metallic Conduits with Liquid-Tight Cover	
LTS, galvanised steel, PVC cover	324
Fittings for Metallic Conduits with Liquid-Tight Cover	
LTS-FMC compression fitting, fixed thread, IP68	325



3.3 Spiral-Reinforced Conduit Systems

Spiral-Reinforced PVC Conduits	
PSR smooth bore	326
Fittings for Spiral-Reinforced PVC Conduits	
PSR-S fixed external thread	327
PSR-90 fixed external thread, 90° elbow	328
FlexiGuard Conduits and Fittings	
FG PVC conduit, steel wire spiral-reinforced	329
FG IP54 fitting, swivel thread	330
FG IP54 fitting with mounting bracket	331



3.4 Conduit System Accessories

HelaGuard Accessories	
Conduit Clips	PACC for corrugated conduits 332
	AFC5 plated steel and PVC liner 333



3.5 Protective Tubing and Spiral Binding

Helawrap Cable Cover and Accessories	
HWPP in polypropylene	334
Helawrap in polyamide 6, UL94 V0	336
Helawrap HWPPMC with metal-content	337
HWClips	338
HWBase	338
HAT application tool	339
Spiral Binding	
SBPE standard polyethylene	340
SBPEFR polyethylene, flame-retardant	341
SBPA standard polyamide 6	342
SBPAV0 polyamide 6, flame-retardant	343
SBPTFE, PTFE	344
SBPEMC metal-content spiral binding	345
SBPPHDR polypropylene, high abrasion-resistant, narrow pitch	346
SBPPHDF polypropylene, high abrasion-resistant, wide pitch	347

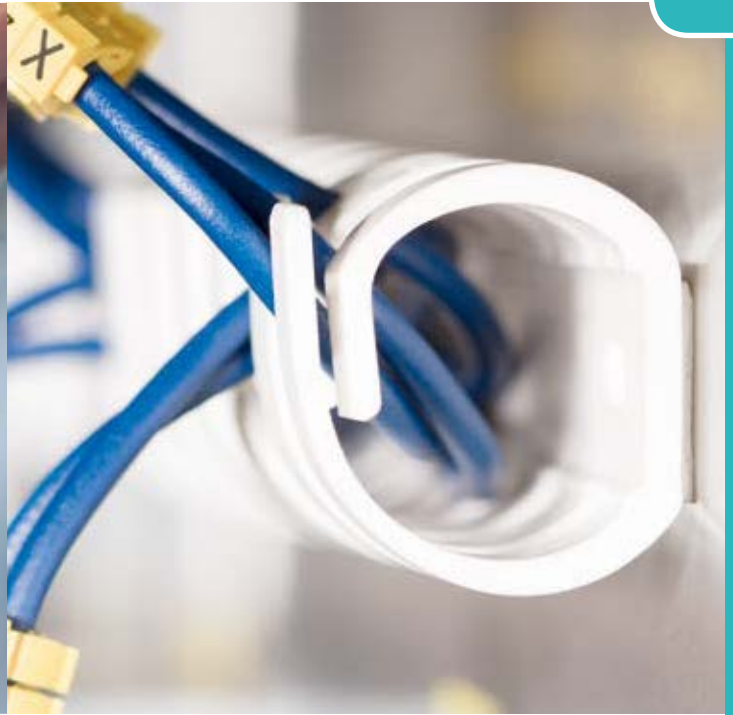

3.6 Protective Sleeves

Expandable Braided Sleeves	
HEGP standard polyester	348
HEGPX high-expansion polyester	349
HEGPETFR polyester, flame-retardant	350
HEGPETFRX high-expansion polyester flame-retardant	351
HEGPA66 polyamide 6.6, abrasion-resistant	352
HEGPL polyester, light weight	353
HLB polyester, in dispenser boxes	354
HEGMAN non-flammable meta-aramid	355
HEGMANWO non-flammable meta-aramid, water and oil-resistant	356
Open Woven Sleeves	
Twist-In self-closing polyester sleeving	357
Twist-In-FR self-closing polyester sleeving, flame-retardant	358
HELAHOOK re-closable polyester sleeving with hook-and-loop seal	359
Burst Protective Sleeves	
HEGWS	360
Electromagnetic Shielding Sleeves	
HEGEMIP electromagnetic protection	361
HEGEMIP-HY electromagnetic protection for hybrid automobiles	362
HEGEMIP-VG electromagnetic protection for defence applications	363



3.7 Wiring Ducts

Rigid PVC Wiring Ducts		
HelaDuct HTWD-PN for small-diameter wires (metric sizes)	364	
HelaDuct HTWD-PW for large-diameter wires (metric sizes)	366	
HelaDuct HTWD-PD (DIN-sizes)	368	
Halogen-Free Wiring Ducts		
HelaDuct HTWD-HF (metric sizes)	370	
Flexible Cable Support		
HelaDuct Flex	screwable	372
	adhesive	372
Wiring Ducts Accessories		
For mounting prior to wiring	HelaDuct HTWD-BWR Base Wire Retainers	373
For mounting to duct fingers	HelaDuct HTWD-NFWR and HTWD-WFWR Wire Retainers	374
For fastening components to base of ducts	HelaDuct HTWD-CTH	375
For installing wiring ducts into fixing holes	HelaDuct HTWD-R4 and HTWD-R6 Rivets	376
For inserting R4 and R6 rivets	HelaDuct HTWD-RT4 and HTWD-RT6 Rivet Tools	376



3.8 Edge Protection

Grommet Strip	
Flexiform G51P polyester edge protection	377
Flexiform G51T PTFE edge protection	378
Flexiform G51N polyamide 6 edge protection	378
Beading	
EdgeGuard PS1, SM1, RA1	379



3.9 Grommets

Push-on Caps	380
Bend Protection Grommets	382
Strain Relief Grommets	384
Edge Protection Grommets	386
Hot Grommet Kit	388

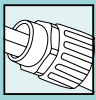

Non-Metallic Conduits

HG-SW PA6 Standard Weight

Standard weight corrugated flexible conduit for industrial applications, including machine building, plant construction, control panels, public buildings.

Features and benefits

- Very flexible and high fatigue life
- Very abrasion resistant
- High impact strength, recovers if crushed
- Highly resistant to solvents and oils
- Free of halogen, sulphur and phosphorus
- Self-extinguishing according to UL94 V2
- Colour: black, grey on request



HelaGuard PA6 Standard for industrial applications.

MATERIAL	Polyamide 6 (PA6)
Operating Temperature	-40 °C to +120 °C
Operating Temperature Moving	-20 °C to +100 °C
Flammability	UL 94 V2

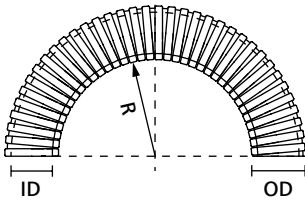

HelaGuard non-metallic conduit

TYPE	Nominal Ø	NW Ø	Outside Ø (OD)	Inside Ø (ID)	Min. Bending Radius (R)	Weight	Reel Length	Colour	Article-No.
HG-SW10	10	7.5	10.0	6.3	15	19 g/m	50 m	Black (BK)	166-11100
HG-SW11	11	8.5	11.5	8.2	20	22 g/m	50 m	Black (BK)	166-11101
HG-SW13	13	10	13.0	9.8	25	28 g/m	50 m	Black (BK)	166-11102
HG-SW16	16	12	15.8	11.8	35	38 g/m	25 m	Black (BK)	166-11110
	16	12	15.8	11.8	35	38 g/m	50 m	Black (BK)	166-11103
HG-SW21	21	17	21.2	16.7	45	60 g/m	25 m	Black (BK)	166-11111
	21	17	21.2	16.7	45	60 g/m	50 m	Black (BK)	166-11104
HG-SW28	28	23	28.5	22.8	50	100 g/m	25 m	Black (BK)	166-11105
	28	23	28.5	22.8	50	100 g/m	50 m	Black (BK)	166-11112
HG-SW34	34	29	34.5	28.1	60	135 g/m	25 m	Black (BK)	166-11106
	34	29	34.5	28.1	60	135 g/m	50 m	Black (BK)	166-11118
HG-SW42	42	36	42.5	35.5	70	165 g/m	25 m	Black (BK)	166-11113
HG-SW54	54	48	54.5	47.2	80	235 g/m	25 m	Black (BK)	166-11114
HG-SW67	67	56	67.2	56.3	130	365 g/m	10 m	Black (BK)	166-11109

All dimensions in mm. Subject to technical changes.

Colour grey available on request. Other reel lengths available on request. Minimum Order Quantity (MOQ) may differ from package content.



For product specific approvals and specifications please refer to the Appendix.



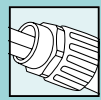

Non-Metallic Conduits

HG-LW PA6 Light Weight

Light weight corrugated flexible conduit for machine building, plant construction, control panels and public buildings.

Features and benefits

- Light weight
- Very flexible and high fatigue life
- Small bending radius
- High impact strength and recovers if crushed
- Highly resistant to solvents and oils
- Free of halogen, sulphur and phosphorus
- Colour: black; grey (RAL 7031) on request



HelaGuard PA6 Light is very flexible and can be used in moving applications.

MATERIAL	Polyamide 6 (PA6)
Operating Temperature	-40 °C to +120 °C
Operating Temperature Moving	-20 °C to +100 °C
Flammability	self-extinguishing according to EN IEC 61386

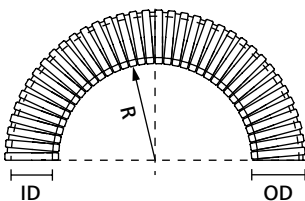

HelaGuard non-metallic conduit

TYPE	Nominal Ø	NW Ø	Outside Ø (OD)	Inside Ø (ID)	Min. Bending Radius (R)	Weight	Reel Length	Colour	Article-No.
HG-LW10	10	7.5	10.0	6.5	15	18 g/m	50 m	Black (BK)	166-11200
HG-LW11	11	8.5	11.5	8.3	20	22 g/m	50 m	Black (BK)	166-11201
HG-LW13	13	10	13.0	10.0	25	24 g/m	50 m	Black (BK)	166-11202
HG-LW16	16	12	15.8	12.0	35	36 g/m	50 m	Black (BK)	166-11203
HG-LW21	21	17	21.2	16.9	40	56 g/m	50 m	Black (BK)	166-11204
HG-LW28	28	23	28.5	23.0	45	90 g/m	50 m	Black (BK)	166-11205
HG-LW34	34	29	34.5	28.3	55	110 g/m	50 m	Black (BK)	166-11206
HG-LW42	42	36	42.5	35.7	65	150 g/m	25 m	Black (BK)	166-11207
HG-LW54	54	48	54.5	47.4	80	200 g/m	25 m	Black (BK)	166-11208
HG-LW67	67	56	67.2	56.5	110	310 g/m	10 m	Black (BK)	166-11209

All dimensions in mm. Subject to technical changes.

Colour grey available on request. Other reel lengths available on request. Minimum Order Quantity (MOQ) may differ from package content.



For product specific approvals and specifications please refer to the Appendix.



Add items to your watchlist!

www.HT.click/49-313



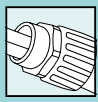

Non-Metallic Conduits

HG-FR PA6 Flame Retardant

Flame-retardant standard weight corrugated flexible conduit is used where high fire-protection is required, including railway vehicles, tunnels and underground stations as well as public buildings.

Features and benefits

- Highly flame retardant (UL94 V0)
- Low smoke, low toxicity
- Very flexible and high fatigue life
- High impact strength, recovers if crushed
- Abrasion resistant
- Highly resistant to solvents and oils
- Free of halogen, sulphur and phosphorus
- Colour: black

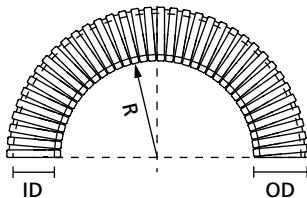

HelaGuard non-metallic conduit



Public buildings often require HelaGuard PA6 Flame Retardant due to its high fire protection properties.

MATERIAL	Polyamide 6, flame retardant (PA6FR)
Operating Temperature	-40 °C to +120 °C
Operating Temperature Moving	-20 °C to +100 °C
Flammability	UL 94 V0
EN 45545-2 Classification	R22 HL3, R23 HL3



TYPE	Nominal Ø	NW Ø	Outside Ø (OD)	Inside Ø (ID)	Min. Bending Radius (R)	Weight	Reel Length	Colour	Article-No.
HG-FR10	10	7.5	10.0	6.3	15	19 g/m	50 m	Black (BK)	166-11400
HG-FR13	13	10	13.0	9.8	25	28 g/m	50 m	Black (BK)	166-11401
HG-FR16	16	12	15.8	11.8	35	38 g/m	50 m	Black (BK)	166-11402
HG-FR21	21	17	21.2	16.7	45	60 g/m	50 m	Black (BK)	166-11403
HG-FR28	28	23	28.5	21.7	50	100 g/m	50 m	Black (BK)	166-11404
HG-FR34	34	29	34.5	28.1	60	135 g/m	50 m	Black (BK)	166-11405
HG-FR42	42	36	42.5	35.5	70	165 g/m	25 m	Black (BK)	166-11406
HG-FR54	54	48	54.5	47.2	80	235 g/m	25 m	Black (BK)	166-11407

All dimensions in mm. Subject to technical changes.

Other reel lengths available on request. Minimum Order Quantity (MOQ) may differ from package content.

EN 45545-2



For product specific approvals and specifications please refer to the Appendix.



Add items to your watchlist!

www.HT.click/49-314



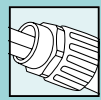

Non-Metallic Conduits

HG-DC Double Slit

Double slit corrugated conduit for retrofitting is used in control panels, machine building, plant construction.

Features and benefits

- Can be opened and closed repeatedly
- Cables can be inserted laterally
- Abrasion resistant
- Free of halogen, sulphur and phosphorus
- Self-extinguishing to IEC 61386
- Colour: black



HelaGuard HG-DC double slit conduit.

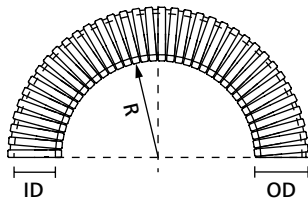

HelaGuard non-metallic conduit

MATERIAL	Polyamide 6 (PA6)
Operating Temperature	-40 °C to +120 °C
Flammability	UL 94 HB



TYPE	Nominal Ø	NW Ø	Outside Ø (OD)	Inside Ø (ID)	Min. Bending Radius (R)	Weight	Reel Length	Colour	Article-No.
HG-DC11	11	8.5	11.5	6.2	45	37 g/m	50 m	Black (BK)	166-11800
HG-DC13	13	10	12.9	7.9	55	46 g/m	50 m	Black (BK)	166-11801
HG-DC16	16	12	16.2	10.3	60	72 g/m	50 m	Black (BK)	166-11802
HG-DC21	21	17	21.0	13.7	90	110 g/m	50 m	Black (BK)	166-11803
HG-DC28	28	23	28.4	19.8	105	166 g/m	50 m	Black (BK)	166-11804
HG-DC34	34	29	34.2	26.6	150	180 g/m	25 m	Black (BK)	166-11805
HG-DC42	42	36	43.5	32.3	170	293 g/m	25 m	Black (BK)	166-11806
HG-DC54	54	48	53.3	44.0	170	400 g/m	25 m	Black (BK)	166-11807

All dimensions in mm. Subject to technical changes.
Other reel lengths available on request. Minimum Order Quantity (MOQ) may differ from package content.



www.HellermannTyton.co.uk/HG-Brochure-cat22

i For more information on our complete HelaGuard range of conduits and fittings, please see our HelaGuard catalogue.



Add items to your watchlist!

www.HT.click/49-315



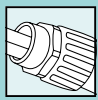

Fittings with fixed external thread

HG-S Straight, IP66

Straight external thread.

Features and benefits

- One piece, fast fit
- High pull-off strength
- Highly resistant to solvents and oils
- Free of halogen, sulphur and phosphorus
- Metric threads supplied with locknuts



Fittings with PG and swivel threads are also available. For our complete range of conduits and fittings, please see our HelaGuard catalogue.



HelaGuard HG-S Straight, IP66.

MATERIAL	Polyamide 6.6 (PA66)
Operating Temperature	-50 °C to +135 °C
Flammability	UL 94 V2

HF ✓

RoHS ✓

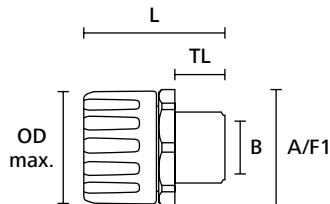

HelaGuard fitting, straight with fixed external thread

TYPE	Nominal Ø	Thread Size	Min. Bore Size (B)	Outside Ø max (OD max.)	Length (L)	A/F Body (A/F1)	Thread Length (TL)	Pack Cont.	Colour	Article-No.
HG10-S-M12	10	M12	7.5	19	33	19	9	10 pcs.	Black (BK)	166-21000
HG10-S-M16	10	M16	9.5	19	35	19	11	10 pcs.	Black (BK)	166-21020
HG11-S-M12	11	M12	7.5	19	33	19	9	10 pcs.	Black (BK)	166-21021
HG13-S-M12	13	M12	7.5	24	35	23	9	10 pcs.	Black (BK)	166-21022
HG13-S-M16	13	M16	11.0	24	37	23	11	10 pcs.	Black (BK)	166-21001
HG13-S-M20	13	M20	12.5	24	40	23	14	10 pcs.	Black (BK)	166-21023
HG16-S-M16	16	M16	11.0	29	41	28	11	10 pcs.	Black (BK)	166-21002
HG16-S-M20	16	M20	14.5	29	34	28	14	10 pcs.	Black (BK)	166-21003
HG20-S-M20	20	M20	14.5	32	44	30	14	10 pcs.	Black (BK)	166-21025
HG21-S-M20	21	M20	14.5	32	44	30	14	10 pcs.	Black (BK)	166-21004
HG25-S-M25	25	M25	19.5	39	49	37	15	10 pcs.	Black (BK)	166-21026
HG28-S-M25	28	M25	19.5	44	49	42	15	10 pcs.	Black (BK)	166-21005
HG28-S-M32	28	M32	26.5	44	50	42	16	10 pcs.	Black (BK)	166-21027
HG34-S-M32	34	M32	26.5	51	53	49	16	10 pcs.	Black (BK)	166-21006
HG34-S-M40	34	M40	32.5	51	53	49	16	10 pcs.	Black (BK)	166-21028
HG42-S-M40	42	M40	32.5	63	60	60	16	2 pcs.	Black (BK)	166-21007
HG42-S-M50	42	M50	40.5	63	60	60	16	2 pcs.	Black (BK)	166-21029
HG54-S-M50	54	M50	42.0	76	65	73	16	2 pcs.	Black (BK)	166-21008
HG54-S-M63	54	M63	53.0	76	65	73	16	2 pcs.	Black (BK)	166-21030
HG67-S-M63	67	M63	56.0	90	70	87	16	1 pc.	Black (BK)	166-21009

All dimensions in mm. Subject to technical changes.

Colour grey available on request. Minimum Order Quantity (MOQ) may differ from package content.



For product specific approvals and specifications please refer to the Appendix.



Add items to your watchlist!

www.HT.click/49-316



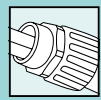

Fittings with fixed external thread

HG-90 90° Elbow, IP66

90° elbow external thread.

Features and benefits

- One piece, fast fit
- High pull-off strength
- Highly resistant to solvents and oils
- Free of halogen, sulphur and phosphorus
- Metric threads supplied with locknuts



Fittings with PG and swivel threads are also available. For our complete range of conduits and fittings, please see our HelaGuard catalogue.



HelaGuard HG-90 90° Elbow, IP66.

MATERIAL	Polyamide 6.6 (PA66)
Operating Temperature	-50 °C to +135 °C
Flammability	UL 94 V2

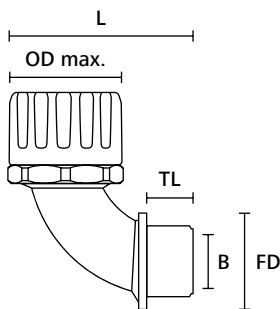

HelaGuard fitting, 90° with fixed internal thread

TYPE	Nominal Ø	Thread Size	Min. Bore Size (B)	Outside Ø max (OD max.)	Length (L)	Face Diameter (FD)	Thread Length (TL)	Pack Cont.	Colour	Article-No.
HG10-90-M12	10	M12	6.5	19	32	17	8	10 pcs.	Black (BK)	166-22200
HG11-90-M12	11	M12	6.5	19	32	17	8	10 pcs.	Black (BK)	166-22220
HG13-90-M16	13	M16	10.5	24	46	22	11	10 pcs.	Black (BK)	166-22201
HG16-90-M16	16	M16	10.5	29	49	22	11	10 pcs.	Black (BK)	166-22202
HG16-90-M20	16	M20	14.0	29	51	27	13	10 pcs.	Black (BK)	166-22203
HG21-90-M20	21	M20	14.0	32	53	27	13	10 pcs.	Black (BK)	166-22204
HG25-90-M25	25	M25	19.0	39	63	32	15	10 pcs.	Black (BK)	166-22222
HG28-90-M25	28	M25	19.0	44	66	32	15	10 pcs.	Black (BK)	166-22205
HG34-90-M32	34	M32	24.5	51	75	40	16	10 pcs.	Black (BK)	166-22206
HG42-90-M40	42	M40	32.5	63	98	50	16	2 pcs.	Black (BK)	166-22207
HG42-90-M50	42	M50	39.0	63	99	60	16	2 pcs.	Black (BK)	166-22223
HG54-90-M50	54	M50	39.0	76	104	60	16	2 pcs.	Black (BK)	166-22208
HG54-90-M63	54	M63	49.5	76	104	72	16	2 pcs.	Black (BK)	166-22224
HG67-90-M63	67	M63	49.5	90	120	72	16	1 pc.	Black (BK)	166-22209

All dimensions in mm. Subject to technical changes.
Colour grey available on request. Minimum Order Quantity (MOQ) may differ from package content.



For product specific approvals and specifications please refer to the Appendix.



Add items to your watchlist!

www.HT.click/49-317





Metallic conduits

SC Galvanised Steel Conduit

General purpose flexible steel conduit offers high mechanical protection and is typically used in machines, plants, underfloor wiring, data cabling and protection of hydraulic or pneumatic hoses.

Features and benefits

- High compression, tensile and impact strength
- Very flexible

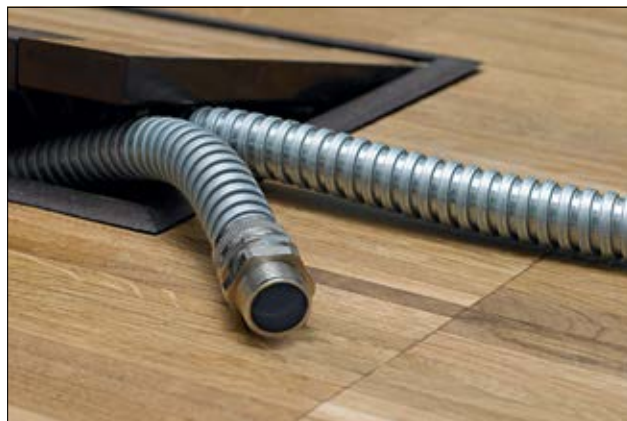

HelaGuard SC Galvanised Steel Conduit.

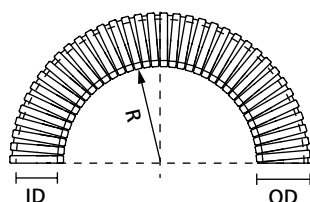

HelaGuard metallic conduit

MATERIAL	Galvanised Steel (GS)
Operating Temperature	-100 °C to +300 °C

HF ✓

RoHS ✓

TYPE	Nominal Ø	Outside Ø (OD)	Inside Ø (ID)	Min. Bending Radius (R)	Weight	Reel Length	Colour	Article-No.
SC10	10	9.1	6.8	25	110 g/m	50 m	Metal (ML)	166-30100
SC12	12	13.2	10.0	30	113 g/m	50 m	Metal (ML)	166-30101
SC16	16	16.4	12.9	40	152 g/m	25 m	Metal (ML)	166-30102
SC20	20	20.6	16.9	45	295 g/m	25 m	Metal (ML)	166-30103
SC25	25	24.6	21.1	55	321 g/m	25 m	Metal (ML)	166-30104
SC32	32	32.0	28.1	70	450 g/m	25 m	Metal (ML)	166-30105
SC40	40	42.5	37.6	80	519 g/m	25 m	Metal (ML)	166-30106
SC50	50	53.2	48.4	90	802 g/m	25 m	Metal (ML)	166-30107

All dimensions in mm. Subject to technical changes.

Other reel lengths available on request. Minimum Order Quantity (MOQ) may differ from package content.



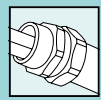

Metallic conduits

SSC Stainless Steel Conduit

Stainless steel, corrosion-resistant flexible conduit used for protection of sensor cables, instrumentation tubing, as well as hydraulic and pneumatic hoses, particularly in corrosive environments. Commonly used in hospitals and clinics.

Features and benefits

- Highly resistant to rust and corrosion
- High compression, tensile and impact strength
- Very flexible



The HelaGuard SSC stainless steel conduit offers superior mechanical protection in corrosive environments.

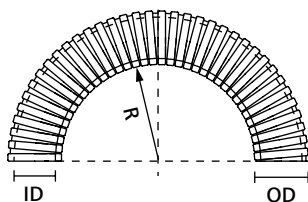

HelaGuard metallic conduit

MATERIAL	Stainless Steel (SS316)
Operating Temperature	-100 °C to +600 °C



TYPE	Nominal Ø	Outside Ø (OD)	Inside Ø (ID)	Min. Bending Radius (R)	Weight	Reel Length	Colour	Article-No.
SSC10	10	9.1	6.8	25	110 g/m	25 m	Metal (ML)	166-30200
SSC12	12	12.3	10.0	40	126 g/m	25 m	Metal (ML)	166-30201
SSC16	16	16.4	13.0	40	162 g/m	25 m	Metal (ML)	166-30202
SSC20	20	20.4	16.9	45	202 g/m	25 m	Metal (ML)	166-30203
SSC25	25	24.3	21.1	55	300 g/m	25 m	Metal (ML)	166-30204
SSC32	32	31.7	28.1	70	340 g/m	25 m	Metal (ML)	166-30205
SSC40	40	42.1	37.6	80	410 g/m	10 m	Metal (ML)	166-30206
SSC50	50	52.8	48.4	90	516 g/m	10 m	Metal (ML)	166-30207

All dimensions in mm. Subject to technical changes.
Other reel lengths available on request. Minimum Order Quantity (MOQ) may differ from package content.



www.HellermannTyton.co.uk/HG-Brochure-cat22

i For more information on our complete HelaGuard range of conduits and fittings, please see our HelaGuard catalogue.



Add items to your watchlist!
www.HT.click/49-319



Fittings for metallic conduits

SC-FM Fixed External Thread

Fixed external thread, nickel plated brass.

Features and benefits

- Multi-part fitting of shell and body with external thread
- Provides tight, reliable hold of conduit
- Can be secured with locknut



Fittings with PG and swivel threads are also available. For our complete range of conduits and fittings, please see our HelaGuard catalogue.



HelaGuard SC-FM Fixed External Thread.

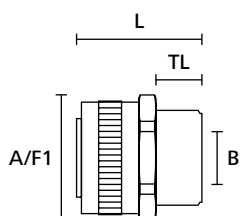

HelaGuard fitting, straight with fixed external thread

MATERIAL	Nickel Plated Brass (NPB)
Operating Temperature	-100 °C to +300 °C



TYPE	Nominal Ø	Thread Size	Min. Bore Size (B)	Length (L)	A/F Body (A/F1)	Thread Length (TL)	Pack Cont.	Colour	Article-No.
SC10-FM-M12	10	M12	5.6	21.0	13	7.0	10 pcs.	Metal (ML)	166-30300
SC12-FM-M16	12	M16	8.5	23.0	17	10.0	10 pcs.	Metal (ML)	166-30301
SC16-FM-M16	16	M16	11.5	25.0	20	10.0	10 pcs.	Metal (ML)	166-30302
SC16-FM-M20	16	M20	11.5	25.0	22	10.0	10 pcs.	Metal (ML)	166-30303
SC20-FM-M20	20	M20	15.3	26.3	24	10.0	10 pcs.	Metal (ML)	166-30304
SC25-FM-M25	25	M25	19.1	29.5	29	10.0	10 pcs.	Metal (ML)	166-30305
SC32-FM-M32	32	M32	26.2	36.8	36	13.0	2 pcs.	Metal (ML)	166-30306
SC40-FM-M40	40	M40	34.6	39.0	48	14.0	2 pcs.	Metal (ML)	166-30307
SC50-FM-M50	50	M50	44.7	42.0	58	15.0	1 pc.	Metal (ML)	166-30308

All dimensions in mm. Subject to technical changes.
Minimum Order Quantity (MOQ) may differ from package content.





Metallic conduits with plastic coating

PCS Galvanised Steel Conduit, PVC Coating

Flexible galvanised steel conduit with PVC coating, typically used in machine and plant construction and electrical installations.

Features and benefits

- High compression, tensile and impact strength
- Very flexible
- Good resistance to alkalis and acids
- Good resistance to chemicals
- Colour: black, grey



HelaGuard PCS Galvanised Steel Conduit with PVC Coating.

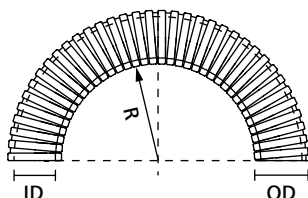

HelaGuard metallic conduit, plastic coating

MATERIAL	Galvanised Steel (GS), Polyvinylchloride (PVC)
Operating Temperature	-15 °C to +70 °C

RoHS

TYPE	Nominal Ø	Outside Ø (OD)	Inside Ø (ID)	Min. Bending Radius (R)	Weight	Reel Length	Colour	Article-No.
PCS10	10	10.1	6.8	25	140 g/m	50 m	Black (BK)	166-30700
PCS12	12	14.2	10.2	30	143 g/m	50 m	Black (BK)	166-30701
PCS16	16	17.1	13.0	40	196 g/m	25 m	Black (BK)	166-30702
PCS20	20	21.6	16.9	45	345 g/m	25 m	Black (BK)	166-30703
PCS25	25	26.0	21.1	55	411 g/m	25 m	Black (BK)	166-30704
PCS32	32	34.0	28.1	60	560 g/m	25 m	Black (BK)	166-30705
PCS40	40	44.2	37.6	80	719 g/m	25 m	Black (BK)	166-30706
PCS50	50	55.0	48.4	90	1,052 g/m	25 m	Black (BK)	166-30707
PCS63	63	64.5	57.5	115	1,091 g/m	10 m	Black (BK)	166-30708
PCS75	75	79.2	70.0	150	1,459 g/m	10 m	Black (BK)	166-30709

All dimensions in mm. Subject to technical changes.
Other reel lengths available on request. Minimum Order Quantity (MOQ) may differ from package content.



Add items to your watchlist!

www.HT.click/49-321





Fittings for metallic conduits with plastic coating

PCS-FM Fixed External Thread, IP54

Fixed external thread, nickel plated brass.

Features and benefits

- Two-part fitting of shell and body with external thread
- Provides tight, reliable hold of conduit
- Can be secured with locknut



Fittings with PG and swivel threads are also available. For our complete range of conduits and fittings, please see our HelaGuard catalogue.



HelaGuard PCS-FM Fixed External Thread.

MATERIAL	Nickel Plated Brass (NPB)
Operating Temperature	-100 °C to +300 °C

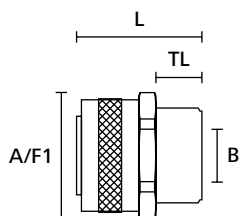

HelaGuard fitting, straight with fixed external thread

TYPE	Nominal Ø	Thread Size	Min. Bore Size (B)	Length (L)	A/F Body (A/F1)	Thread Length (TL)	Pack Cont.	Colour	Article-No.
PCS10-FM-M12	10	M12	5.6	21.0	13	8.0	10 pcs.	Metal (ML)	166-31000
PCS12-FM-M16	12	M16	8.5	23.0	17	8.0	10 pcs.	Metal (ML)	166-31001
PCS16-FM-M16	16	M16	11.5	25.0	20	10.0	10 pcs.	Metal (ML)	166-31002
PCS16-FM-M20	16	M20	11.5	25.0	22	10.0	10 pcs.	Metal (ML)	166-31003
PCS20-FM-M20	20	M20	15.3	26.3	24	10.0	10 pcs.	Metal (ML)	166-31004
PCS25-FM-M25	25	M25	19.1	32.5	29	10.0	10 pcs.	Metal (ML)	166-31005
PCS32-FM-M32	32	M32	26.2	36.8	36	13.0	2 pcs.	Metal (ML)	166-31006
PCS40-FM-M40	40	M40	34.6	39.0	48	14.0	2 pcs.	Metal (ML)	166-31007
PCS50-FM-M50	50	M50	44.7	42.0	58	15.0	1 pc.	Metal (ML)	166-31008
PCS63-FM-M63	63	M63	54.5	50.0	70	18.0	1 pc.	Metal (ML)	166-31009
PCS75-FM-M75	75	M75	66.5	60.0	84	20.0	1 pc.	Metal (ML)	166-31019

All dimensions in mm. Subject to technical changes.
Minimum Order Quantity (MOQ) may differ from package content.



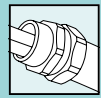

Fittings for metallic conduits with plastic coating

PCS-FMC Fixed Thread Compression Fitting, IP65

External thread, nickel plated brass.

Fulfils IP65.

Features and benefits

- Multipart compression fitting including elastomeric seal
- Provides excellent tensile strength
- Can be used for knockouts or threaded entries as fitting rotates until tightened



HelaGuard PCS-FMC Compression Fitting.

i Fittings with PG and swivel threads are also available. For our complete range of conduits and fittings, please see our HelaGuard catalogue.

MATERIAL	Nickel Plated Brass (NPB), Thermoplastic Elastomer (TPE)	Nickel Plated Brass (NPB), Polyamide 6 (PA6)
Operating Temperature	-50 °C to +135 °C	

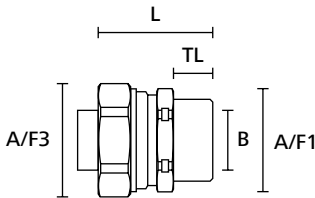

HelaGuard compression fitting, straight with fixed external thread



TYPE	Nominal Ø	Thread Size	Min. Bore Size (B)	Length (L)	A/F Body (A/F1)	A/F Nut (A/F3)	Thread Length (TL)	Pack Cont.	Colour	Article-No.
PCS10-FMC-M12	10	M12	5.6	29.8	20	20	10.0	10 pcs.	Metal (ML)	166-31400
PCS12-FMC-M16	12	M16	8.6	29.8	20	22	10.0	10 pcs.	Metal (ML)	166-31401
PCS16-FMC-M16	16	M16	11.5	33.0	24	26	12.0	10 pcs.	Metal (ML)	166-31402
PCS16-FMC-M20	16	M20	11.5	33.0	24	26	12.0	10 pcs.	Metal (ML)	166-31403
PCS20-FMC-M20	20	M20	15.3	33.5	26	29	12.0	10 pcs.	Metal (ML)	166-31404
PCS25-FMC-M25	25	M25	19.1	40.5	33	35	14.0	10 pcs.	Metal (ML)	166-31405
PCS32-FMC-M32	32	M32	26.0	45.8	40	42	15.0	2 pcs.	Metal (ML)	166-31406
PCS40-FMC-M40	40	M40	34.6	47.5	56	58	16.0	2 pcs.	Metal (ML)	166-31407
PCS50-FMC-M50	50	M50	44.7	51.0	70	70	16.0	1 pc.	Metal (ML)	166-31408

All dimensions in mm. Subject to technical changes.
Minimum Order Quantity (MOQ) may differ from package content.



Add items to your watchlist!

www.HT.click/49-323





Metallic conduits with liquid-tight cover

LTS Galvanised steel conduit, PVC cover

Flexible galvanised steel conduit with smooth, liquid-tight PVC cover. Fulfills IP66, IP67, IP68 and IP69k with LTS-fittings. LTS is used in machine tools and outdoor installations, wherever liquid-tight is a requirement.

Features and benefits

- Liquid-tight (IP68 and IP69k with LTS fittings)
- High compression, tensile and impact strength
- Good flexibility
- Smooth outer cover does not wrinkle when bent
- Good resistance to acids, petrol, oils and greases
- Suitable for outdoor use



HelaGuard LTS.

MATERIAL	Galvanised Steel (GS), Polyvinylchloride (PVC)
Operating Temperature	-20 °C to +105 °C

RoHS ✓

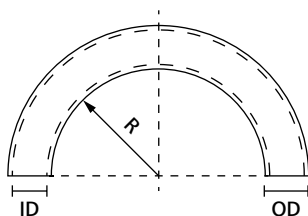

HelaGuard liquid-tight metallic conduit, plastic coating

TYPE	Nominal Ø	US Trade Size	Outside Ø (OD)	Inside Ø (ID)	Min. Bending Radius (R)	Weight	Reel Length	Colour	Article-No.
LTS10	10	1/4 "	11.8	7.0	35	185 g/m	50 m	Black (BK)	166-31900
LTS12	12	5/16 "	14.2	10.0	40	203 g/m	25 m	Black (BK)	166-31901
LTS16	16	3/8 "	17.8	12.6	45	311 g/m	25 m	Black (BK)	166-31902
LTS20	20	1/2 "	21.1	16.0	65	407 g/m	25 m	Black (BK)	166-31903
LTS25	25	3/4 "	26.4	21.1	100	503 g/m	25 m	Black (BK)	166-31904
LTS32	32	1 "	33.1	26.5	135	732 g/m	25 m	Black (BK)	166-31905
LTS40	40	1 1/4 "	41.8	35.4	175	885 g/m	25 m	Black (BK)	166-31906
LTS50	50	1 1/2 "	47.9	40.4	230	1,240 g/m	25 m	Black (BK)	166-31907
LTS63	63	2 "	59.7	51.6	280	1,470 g/m	10 m	Black (BK)	166-31908

All dimensions in mm. Subject to technical changes.
Other reel lengths available on request. Minimum Order Quantity (MOQ) may differ from package content.



For product specific approvals and specifications please refer to the Appendix.



Add items to your watchlist!

www.HT.click/49-324



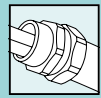

Fittings for metallic conduits with liquid-tight cover

LTS-FMC Fixed Thread Compression Fitting, IP68

External thread, nickel plated brass.

Fulfils IP66, IP67, IP68 and IP69k.

Features and benefits

- Multipart compression fitting including elastomeric seal
- Provides excellent tensile strength
- Can be used for knockouts or threaded entries as fitting rotates until tightened



Fittings with PG and swivel threads are also available. For our complete range of conduits and fittings, please see our HelaGuard catalogue.



HelaGuard LTS-FMC Compression Fitting.

MATERIAL	Nickel Plated Brass (NPB), Polyamide 6 (PA6)
Operating Temperature	-50 °C to +135 °C

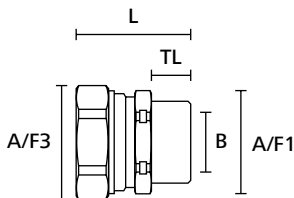

HelaGuard compression fitting, straight with fixed external thread

TYPE	Nominal Ø	Thread Size	Min. Bore Size (B)	Length (L)	A/F Body (A/F1)	A/F Nut (A/F3)	Thread Length (TL)	Pack Cont.	Colour	Article-No.
LTS10-FMC-M12	10	M12	5.6	29.8	20	20	10.0	10 pcs.	Metal (ML)	166-32200
LTS10-FMC-M16	10	M16	5.6	29.8	20	20	10.0	10 pcs.	Metal (ML)	166-32201
LTS12-FMC-M16	12	M16	8.6	29.8	20	22	10.0	10 pcs.	Metal (ML)	166-32203
LTS16-FMC-M16	16	M16	10.7	33.0	24	26	12.0	10 pcs.	Metal (ML)	166-32204
LTS16-FMC-M20	16	M20	10.7	33.0	24	26	12.0	10 pcs.	Metal (ML)	166-32205
LTS20-FMC-M20	20	M20	14.5	33.5	26	29	12.0	10 pcs.	Metal (ML)	166-32206
LTS25-FMC-M25	25	M25	18.0	40.5	33	35	14.0	10 pcs.	Metal (ML)	166-32207
LTS32-FMC-M32	32	M32	24.6	45.8	40	42	15.0	2 pcs.	Metal (ML)	166-32208
LTS40-FMC-M40	40	M40	32.7	47.5	50	52	16.0	1 pc.	Metal (ML)	166-32209
LTS50-FMC-M50	50	M50	37.7	53.0	58	58	18.0	1 pc.	Metal (ML)	166-32210
LTS63-FMC-M63	63	M63	49.0	58.8	70	70	20.0	1 pc.	Metal (ML)	166-32211

All dimensions in mm. Subject to technical changes.
Minimum Order Quantity (MOQ) may differ from package content.



Add items to your watchlist!

www.HT.click/49-325



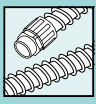

Spiral-reinforced PVC Conduits

PSR Conduit

Flexible, smooth bore conduit with spiral rigid PVC reinforcement and flexible PVC cover. PSR conduits are typically used in machine building, plant construction, shipbuilding, automation, and electrical installations.

Features and benefits

- Extremely flexible
- Withstands torsional movement
- Self-extinguishing
- Easy to feed cables into conduit
- Can be used with PSR fittings
- Colour: grey; black, green (oil resistant) or blue (high temperature resistant) upon request



PSR is extremely flexible and allows for easy insertion of cables.



PSR conduit with higher resistance to oil (color: green) and temperature (colour: blue) available on request.

MATERIAL	Polyvinylchloride (PVC)
Operating Temperature	-20 °C to +70 °C
Flammability	self-extinguishing according to EN IEC 61386

RoHS ✓

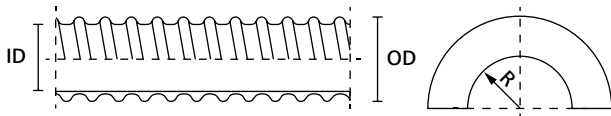

HelaGuard spiral reinforced conduit

TYPE	Nominal Ø	Outside Ø (OD)	Inside Ø (ID)	Min. Bending Radius (R)	Weight	Reel Length	Colour	Article-No.
PSR12	12	14.5	10	25	71 g/m	30 m	Grey (GY)	166-40001
PSR16	16	16.5	12	25	76 g/m	30 m	Grey (GY)	166-40002
PSR20	20	21.0	16	35	112 g/m	30 m	Grey (GY)	166-40003
PSR25	25	27.5	22	45	153 g/m	30 m	Grey (GY)	166-40004
PSR32	32	33.5	28	60	327 g/m	30 m	Grey (GY)	166-40005
PSR40	40	41.0	35	80	448 g/m	30 m	Grey (GY)	166-40006
PSR50	50	46.4	40	105	725 g/m	30 m	Grey (GY)	166-40007
PSR63	63	57.0	50	120	948 g/m	30 m	Grey (GY)	166-40008

All dimensions in mm. Subject to technical changes.
Minimum Order Quantity (MOQ) may differ from package content.



For product specific approvals and specifications please refer to the Appendix.



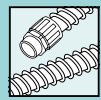

Fittings for spiral-reinforced PVC Conduits

PSR-S Straight fitting

Straight PA66 fitting, fixed external thread.

Fulfils IP65 with PSR conduits.

Fulfils IP66 and IP67 with PSRSC conduits.

Features and benefits

- High pull-off strength
- Highly resistant to solvents and oils
- Free of halogen, sulphur and phosphorus
- Metric threads supplied with locknuts
- Fits both PSR and PSRSC conduits



PSR-S Straight.

i Fittings with PG-Thread and in 90° and 45° are also available. For our complete range of conduits and fittings, please see our HelaGuard catalogue.

MATERIAL	Polyamide 6.6 (PA66)
Operating Temperature	-50 °C to +135 °C
Flammability	UL 94 V2

HF ✓

RoHS ✓

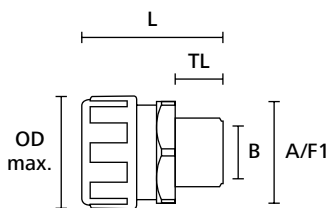

HelaGuard fitting, straight with fixed external thread

TYPE	Nominal Ø	Thread Size	Min. Bore Size (B)	Outside Ø max (OD max.)	Length (L)	A/F Body (A/F1)	Thread Length (TL)	Pack Cont.	Colour	Article-No.
PSR12-S-M16	12	M16	9.0	24	38	23	11	10 pcs.	Grey (GY)	166-40701
PSR16-S-M16	16	M16	10.5	28	40	25	11	10 pcs.	Grey (GY)	166-40702
PSR16-S-M20	16	M20	10.5	28	41	25	14	10 pcs.	Grey (GY)	166-40703
PSR20-S-M20	20	M20	14.5	33	43	30	14	10 pcs.	Grey (GY)	166-40704
PSR25-S-M25	25	M25	19.0	42	45	37	15	10 pcs.	Grey (GY)	166-40705
PSR32-S-M32	32	M32	24.5	48	48	45	16	10 pcs.	Grey (GY)	166-40706
PSR40-S-M40	40	M40	33.0	60	59	60	16	2 pcs.	Grey (GY)	166-40707
PSR50-S-M50	50	M50	39.0	64	55	60	16	2 pcs.	Grey (GY)	166-40708
PSR63-S-M63	63	M63	48.0	76	56	73	16	1 pc.	Grey (GY)	166-40709

All dimensions in mm. Subject to technical changes.
Minimum Order Quantity (MOQ) may differ from package content.



For product specific approvals and specifications please refer to the Appendix.



Add items to your watchlist!

www.HT.click/49-327

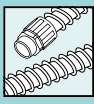

Fittings for spiral-reinforced PVC Conduits

PSR-90 90° elbow fitting

90° PA66 fitting, fixed external thread.

Fulfils IP65 with PSR conduits.

Fulfils IP66 and IP67 with PSRSC conduits.

Features and benefits

- High pull-off strength
- Highly resistant to solvents and oils
- Free of halogen, sulphur and phosphorus
- Metric threads supplied with locknuts
- Fits both PSR and PSRSC conduits



PSR-90 90° Elbow.

i Fittings with PG-Thread and in 90° and 45° are also available. For our complete range of conduits and fittings, please see our HelaGuard catalogue.

MATERIAL	Polyamide 6.6 (PA66)
Operating Temperature	-50 °C to +135 °C
Flammability	UL 94 V2

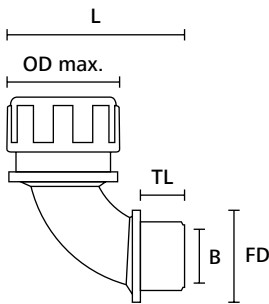

HelaGuard fitting, 90° with fixed external thread

TYPE	Nominal Ø	Thread Size	Min. Bore Size (B)	Outside Ø max (OD max.)	Length (L)	Face Diameter (FD)	Thread Length (TL)	Pack Cont.	Article-No.
PSR16-90-M16	16	M16	10.5	28	49	22	11	10 pcs.	166-40801
PSR16-90-M20	16	M20	10.5	28	51	27	13	10 pcs.	166-40802
PSR20-90-M20	20	M20	14.5	33	52	27	13	10 pcs.	166-40803
PSR25-90-M25	25	M25	19.0	42	63	33	15	10 pcs.	166-40804
PSR32-90-M32	32	M32	24.5	48	74	40	16	2 pcs.	166-40805
PSR40-90-M40	40	M40	33.0	60	113	50	16	2 pcs.	166-40806

All dimensions in mm. Subject to technical changes.
Minimum Order Quantity (MOQ) may differ from package content.



For product specific approvals and specifications please refer to the Appendix.



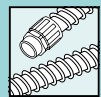

FlexiGuard Conduits & Fittings

FlexiGuard PVC Protective Conduits

FlexiGuard protective hoses are used to protect cables in machines and plant construction, and robotics as well as leads to switch cabinets.

Features and benefits

- Extremely flexible
- Excellent mechanical protection
- Resistant to oils, acids, alkalis and chemicals



FlexiGuard FG with FG-UH fitting.

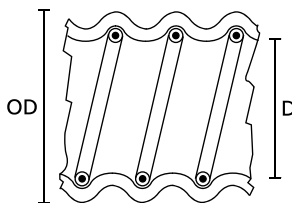

FlexiGuard

MATERIAL	Flexible Polyvinyl Chloride, cadmium free (PVC), Steel (ST)
Operating Temperature	-20 °C to +70 °C, (+80 °C, 200 h)
Flammability	UL 94 HB



TYPE	Nominal Ø	Inside Ø (ID)	Outside Ø (OD)	Min. Bending Radius (R)	Reel Length	Colour	Pack Cont.	Article-No.
FG14	14	10	14	14	10 m	Grey (GY)	10 m	167-00209
FG17	17	13	17	17	10 m	Grey (GY)	10 m	167-00211
FG19	19	15	19	19	10 m	Grey (GY)	10 m	167-00213
FG21	21	16	21	21	10 m	Grey (GY)	10 m	167-00216
FG27	27	21	27	27	10 m	Grey (GY)	10 m	167-00221
FG36	36	30	36	36	10 m	Grey (GY)	10 m	167-00229
FG45	45	38	45	45	10 m	Grey (GY)	10 m	167-00236
FG56	56	48	56	56	10 m	Grey (GY)	10 m	167-00248

All dimensions in mm. Subject to technical changes.
Minimum Order Quantity (MOQ) may differ from package content.



www.HellermannTyton.co.uk/HG-Brochure-cat22

i For more information on our complete HelaGuard range of conduits and fittings, please see our HelaGuard catalogue.



Add items to your watchlist!

www.HT.click/49-329





FlexiGuard Conduits & Fittings

FG-M Fittings

Straight swivel external thread.

Fulfils IP54 with FlexiGuard FG conduits.

Features and benefits

- One piece, easy fit
- Swivel thread
- Vibration and tension resistant
- Large bore size
- Inner ferrule protects cables
- Good resistance to chemicals



FG conduit fitting.

MATERIAL	Polypropylene (PP)
Operating Temperature	-35 °C to +80 °C
Flammability	UL 94 V2

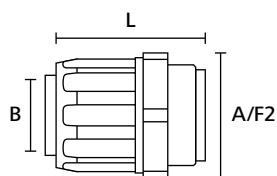

FlexiGuard fitting, straight with swivel thread

TYPE	Nominal Ø	Thread Size	Min. Bore Size (B)	Length (L)	A/F Thread (A/F2)	Colour	Pack Cont.	Article-No.
FG14-M16	14	M16	8.8	41.5	20	Grey (GY)	10 pcs.	167-00530
FG14-PG9	14	PG9	8.8	41.5	20	Grey (GY)	10 pcs.	167-00510
FG17-M20	17	M20	11.1	45.0	24	Grey (GY)	10 pcs.	167-00531
FG17-PG11	17	PG11	11.1	45.0	24	Grey (GY)	10 pcs.	167-00511
FG19-PG13	19	PG13.5	13.0	47.5	27	Grey (GY)	10 pcs.	167-00512
FG21-M25	21	M25	14.8	49.5	30	Grey (GY)	10 pcs.	167-00533
FG21-PG16	21	PG16	14.8	49.5	30	Grey (GY)	10 pcs.	167-00513
FG27-M32	27	M32	19.4	52.0	36	Grey (GY)	10 pcs.	167-00534
FG27-PG21	27	PG21	19.4	52.0	36	Grey (GY)	10 pcs.	167-00514
FG36-M40	36	M40	27.9	54.8	46	Grey (GY)	10 pcs.	167-00535
FG36-PG29	36	PG29	27.9	54.8	46	Grey (GY)	10 pcs.	167-00515
FG45-M50	45	M50	35.6	58.0	55	Grey (GY)	10 pcs.	167-00536
FG45-PG36	45	PG36	35.6	58.0	55	Grey (GY)	10 pcs.	167-00516
FG56-M63	56	M63	45.9	60.0	65	Grey (GY)	10 pcs.	167-00537
FG56-PG48	56	PG48	45.9	60.0	65	Grey (GY)	10 pcs.	167-00517

All dimensions in mm. Subject to technical changes.
Minimum Order Quantity (MOQ) may differ from package content.



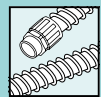

FlexiGuard Conduits & Fittings

FG-UH Fittings with Bracket

Straight swivel bracket.

Fulfils IP54 with FlexiGuard FG conduits.

Features and benefits

- One piece, easy fit
- Swivel bracket
- Vibration and tension resistant
- Large bore size
- Inner ferrule protects cables
- Good resistance to chemicals



FG-UH fitting with bracket.

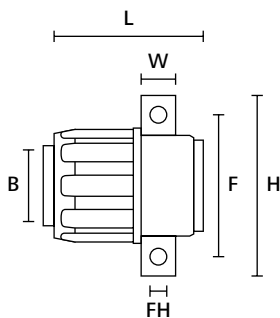

FlexiGuard fitting, straight with bracket

MATERIAL	Polypropylene (PP)
Operating Temperature	-35 °C to +80 °C
Flammability	UL 94 V2



TYPE	Nominal Ø	Min. Bore Size (B)	Length (L)	Width (W)	Height (H)	Hole Ø (FH)	Fixing Hole Centres (F)	Colour	Pack Cont.	Article-No.
FG14-UH	14	8.8	41.5	10.0	40.0	5.7	29.0	Grey (GY)	10 pcs.	167-00520
FG17-UH	17	11.1	45.0	12.0	50.0	5.7	37.0	Grey (GY)	10 pcs.	167-00521
FG19-UH	19	13.0	47.5	12.0	50.0	5.7	37.0	Grey (GY)	10 pcs.	167-00522
FG21-UH	21	14.8	49.5	12.0	50.0	5.7	37.0	Grey (GY)	10 pcs.	167-00523
FG27-UH	27	19.4	52.0	12.5	57.0	5.7	43.0	Grey (GY)	10 pcs.	167-00524
FG36-UH	36	27.9	54.8	13.0	67.0	6.7	53.0	Grey (GY)	10 pcs.	167-00525
FG45-UH	45	35.6	58.0	14.0	79.5	6.7	65.0	Grey (GY)	10 pcs.	167-00526
FG56-UH	56	45.9	60.0	16.5	92.5	6.7	76.0	Grey (GY)	10 pcs.	167-00527

All dimensions in mm. Subject to technical changes.
Minimum Order Quantity (MOQ) may differ from package content.



Add items to your watchlist!

www.HT.click/49-331





HelaGuard Accessories

PACC Clip for Corrugated Conduits

Features and benefits

- Easy and quick assembly with non-metallic conduits
- Lid is integrated
- Hole for fastening with screw
- Inner rib prevents conduit from slipping
- Can be used in C-shaped DIN rails



HelaGuard PACC Conduit Clip.

MATERIAL	Polyamide 6.6 (PA66)
Operating Temperature	-50 °C to +135 °C
Flammability	UL 94 V2

HF ✓

RoHS ✓

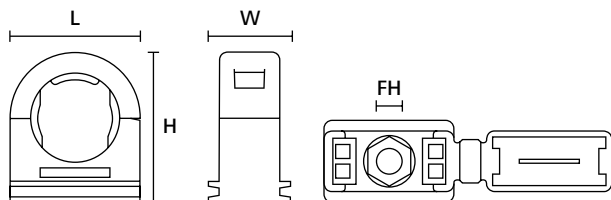

HelaGuard conduit clip, side views

HelaGuard conduit clip, top view

TYPE	Nominal Ø	Height (H)	Width (W)	Length (L)	Hole Ø (FH)	Pack Cont.	Colour	Article-No.
PACC10	10	26	12	23	M5	10 pcs.	Black (BK)	166-25707
PACC13	13	26	12	23	M5	10 pcs.	Black (BK)	166-25700
PACC16	16	30	12	26	M5	10 pcs.	Black (BK)	166-25701
PACC21	21	36	15	32	M6	10 pcs.	Black (BK)	166-25702
PACC28	28	45	15	41	M6	10 pcs.	Black (BK)	166-25703
PACC34	34	51	15	48	M6	10 pcs.	Black (BK)	166-25704
PACC42	42	60	15	57	M6	5 pcs.	Black (BK)	166-25705
PACC54	54	72	15	70	M6	5 pcs.	Black (BK)	166-25706

All dimensions in mm. Subject to technical changes.
Minimum Order Quantity (MOQ) may differ from package content.



www.HellermannTyton.co.uk/HG-Brochure-cat22



For more information on our complete HelaGuard range of conduits and fittings, please see our HelaGuard catalogue.



Add items to your watchlist!

www.HT.click/49-332



HelaGuard Accessories

AFCS Fixing Clip, Plated Steel and PVC Liner

The AFCS clip is used to secure metallic conduits.

Features and benefits

- Simple, secure fixing of metallic conduits
- Liner prevents damage due to abrasion



HelaGuard AFCS Fixing Clip, Galvanised Steel and PVC Liner.

MATERIAL	Galvanised Steel (GS), Polyvinylchloride (PVC)
Operating Temperature	-20 °C to +105 °C

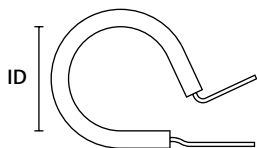

HelaGuard fixing clip, side view

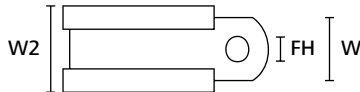

HelaGuard fixing clip, top view

TYPE	Nominal Ø	Inside Ø (ID)	Width (W)	Width (W2)	Hole Ø (FH)	Pack Cont.	Colour	Article-No.
AFCS10	10	11.0	12.7	17.4	5.1	10 pcs.	Metal (ML), Black (BK)	166-50600
AFCS12	12	14.0	12.7	17.4	5.1	10 pcs.	Metal (ML), Black (BK)	166-50601
AFCS16	16	17.0	12.7	17.4	5.1	10 pcs.	Metal (ML), Black (BK)	166-50602
AFCS20	20	21.0	12.7	17.4	5.1	10 pcs.	Metal (ML), Black (BK)	166-50603
AFCS25	25	25.0	12.7	17.4	5.1	10 pcs.	Metal (ML), Black (BK)	166-50604
AFCS32	32	34.0	12.7	17.4	5.1	10 pcs.	Metal (ML), Black (BK)	166-50605
AFCS40	40	44.0	25.4	30.5	14.2 x 17.5	5 pcs.	Metal (ML), Black (BK)	166-50606
AFCS50	50	54.0	25.4	30.5	14.2 x 17.5	5 pcs.	Metal (ML), Black (BK)	166-50607
AFCS63	63	70.0	25.4	30.5	14.2 x 17.5	1 pc.	Metal (ML), Black (BK)	166-50608
AFCS75	75	76.2	25.4	30.5	14.2 x 17.5	1 pc.	Metal (ML), Black (BK)	166-50609

All dimensions in mm. Subject to technical changes.
Minimum Order Quantity (MOQ) may differ from package content.



Add items to your watchlist!

www.HT.click/49-333



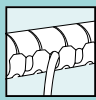

Helawrap cable cover

HWPP for industrial applications

Helawrap is used to bundle and protect cables and wires in the electrical industry, panel building, machine building and many other industrial applications. Helawrap is the time-saving solution for industrial applications.

Features and benefits

- Ideal solution for bundling, protecting and fixing cables
- Quick and effortless to apply
- Good abrasion protection
- Special profile enables branching off cable at any point
- Can be removed and reapplied often
- Available in several colours and sizes
- Handy applicator tool included



www.HellermannTyton.co.uk/HWPP-cat22



Protecting and fixing cables with the Helawrap cable cover and accessory set, for instance in wiring cabinets.

MATERIAL	Polypropylene (PP)
Operating Temperature	-60 °C to +110 °C, intermittent +140 °C
Flammability	UL 94 HB

HF ✓

RoHS ✓

TYPE	Bundle Ø max.	Colour	Reel Length	Application Tool	Article-No.
HWPP8	9	Black (BK)	25 m	HAT8	161-64101
	9	Grey (GY)	25 m	HAT8	161-64102
	9	Silver (SR)	25 m	HAT8	161-64103
	9	White (WH)	25 m	HAT8	161-64104
HWPP16	16	Black (BK)	25 m	HAT16	161-64201
	16	Grey (GY)	25 m	HAT16	161-64202
	16	Silver (SR)	25 m	HAT16	161-64203
	16	White (WH)	25 m	HAT16	161-64207
HWPP20	21	Black (BK)	25 m	HAT20	161-64301
	21	Grey (GY)	25 m	HAT20	161-64302
	21	Silver (SR)	25 m	HAT20	161-64303
	21	White (WH)	25 m	HAT20	161-64304
HWPP25	27	Black (BK)	25 m	HAT25	161-64401
	27	Grey (GY)	25 m	HAT25	161-64402
	27	Silver (SR)	25 m	HAT25	161-64403
	27	White (WH)	25 m	HAT25	161-64407
HWPP30	32	Black (BK)	25 m	HAT30	161-64501
	32	Grey (GY)	25 m	HAT30	161-64502
	32	Silver (SR)	25 m	HAT30	161-64503
	32	White (WH)	25 m	HAT30	161-64504
HWPP40	42	Black (BK)	15 m	HAT40	161-64601

All dimensions in mm. Subject to technical changes.
Minimum Order Quantity (MOQ) may differ from package content.

ECE R-118

For product specific approvals and specifications please refer to the Appendix.



Add items to your watchlist!

www.HT.click/49-334

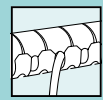

Helawrap cable cover

HWPP for home and office use

Helawrap HWPP in practical 2 metre lengths is designed for home and office use. It puts an end to the cable chaos of PCs, TVs and Hi-Fi systems.

Features and benefits

- Ideal solution for bundling, protecting, mounting and routing cables
- Quick and effortless to apply
- Good abrasion protection
- Special profile enables branching off cable at any point
- Can be removed and reapplied often
- Available in several colours and sizes
- Handy applicator tool included



Helawrap - Office Desktop Cable Management.



To order additional HAT application tools, see page 339.



Complete set including application tool.



Helawrap Cable Cover - HWPP - 2 m black.



Insert one or more cables into the insertion slot of the applicator tool.



Place the HAT applicator tool in one end of the Helawrap cable cover.



Simply slide the HAT applicator tool through the Helawrap cover.

TYPE	Bundle Ø max.	Colour	Length (L)	Application Tool	Article-No.
HWPP16L2	16	Black (BK)	2 m	HAT16	161-64204
	16	Grey (GY)	2 m	HAT16	161-64205
	16	Silver (SR)	2 m	HAT16	161-64206
	16	White (WH)	2 m	HAT16	161-64215
HWPP25L2	27	Black (BK)	2 m	HAT25	161-64404
	27	Grey (GY)	2 m	HAT25	161-64405
	27	Silver (SR)	2 m	HAT25	161-64406
	27	White (WH)	2 m	HAT25	161-64415

All dimensions in mm. Subject to technical changes.
Minimum Order Quantity (MOQ) may differ from package content.

ECE R-118

For product specific approvals and specifications please refer to the Appendix.



Add items to your watchlist!

www.HT.click/49-335



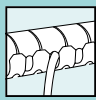

Cable Cover, Material: PA6, UL94V0

Helawrap HWPV0

Helawrap HWPV0 is used to bundle and protect cable and wires, especially if there is vibration and abrasion. HWPV0 has excellent flame-retardant properties and is halogen-free.

Features and benefits

- Ideal solution for bundling, protecting and fixing cables
- Quick and effortless to apply
- Self-extinguishing according to UL94 V0
- Very good abrasion protection
- Special profile enables branching off cable at any point
- Can be removed and reapplied often
- Available in several colours and sizes
- Handy applicator tool included

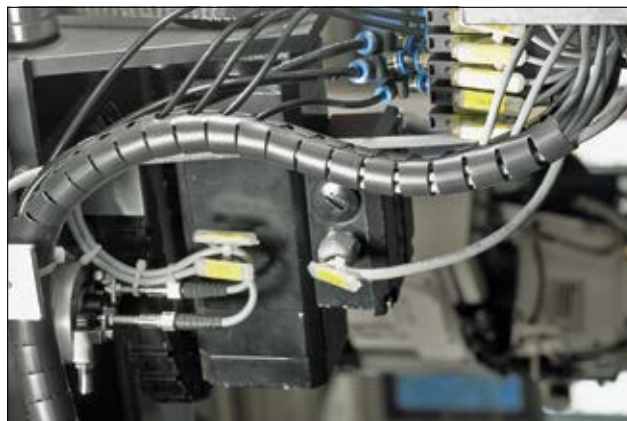

Cables can be branched off at any point for better, more flexible protection.

MATERIAL	Polyamide 6 V0 (PA6V0)
Operating Temperature	-40 °C to +90 °C, intermittent +120 °C
Flammability	UL 94 V0
EN 45545-2 Classification	R22 HL2, R23 HL2



To order additional HAT application tools, see page 339.

TYPE	Bundle Ø max.	Colour	Reel Length	Application Tool	Article-No.
HWPV08	9	Black (BK)	25 m	HAT8	161-63101
HWPV016	16	Black (BK)	25 m	HAT16	161-63201
HWPV020	21	Black (BK)	25 m	HAT20	161-63301
HWPV025	27	Black (BK)	25 m	HAT25	161-63401
HWPV030	32	Black (BK)	25 m	HAT30	161-63501

All dimensions in mm. Subject to technical changes.
Minimum Order Quantity (MOQ) may differ from package content.

EN 45545-2



For product specific approvals and specifications please refer to the Appendix.



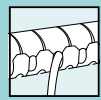

Metal-Content Cable Cover

Helawrap HWPPMC

HWPPMC is particularly suitable for installation and maintenance for food-processing machines and in food-processing plants.

Features and benefits

- High metal-content for reliable detection with standard detection equipment
- Quick and effortless to apply
- Stainless steel preserves resistance to corrosion
- Blue colour for enhanced visibility
- Ideal solution for bundling and protecting cables and hoses
- Highly flexible
- Very good abrasion protection
- Special profile enables branching off cable at any point
- Can be removed and reused
- Handy applicator tool included

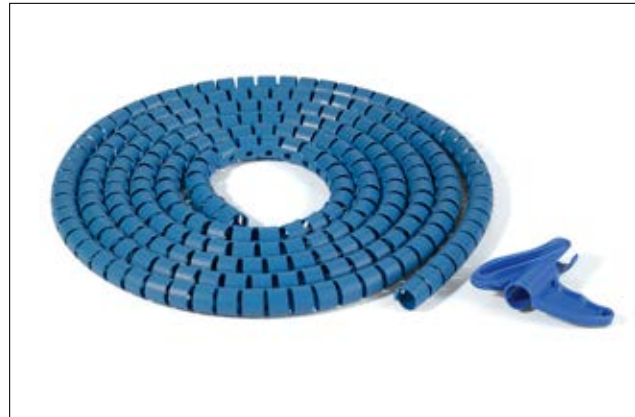

HWPPMC metal-content cable cover.

MATERIAL	Polypropylene (PP), Stainless Steel (SS)
Operating Temperature	-60 °C to +100 °C, intermittent +140 °C
Flammability	UL 94 HB



Can support quality assurance in the production of food stuffs, for example HACCP.



To order additional HAT application tools, see page 339.

TYPE	Bundle Ø max.	Colour	Reel Length	Application Tool	Article-No.
HWPPMC8	9	Blue (BU)	25 m	HAT8	161-66000
HWPPMC16	16	Blue (BU)	25 m	HAT16	161-66100
HWPPMC20	21	Blue (BU)	25 m	HAT20	161-66200
HWPPMC25	27	Blue (BU)	25 m	HAT25	161-66300
HWPPMC30	32	Blue (BU)	25 m	HAT30	161-66400

All dimensions in mm. Subject to technical changes.
Minimum Order Quantity (MOQ) may differ from package content.



Add items to your watchlist!

www.HT.click/49-337





Accessories for retaining Helawrap Open Cable Cover

HWClips

To complete the Helawrap cable management system various Helawrap Clips in compatible sizes are available. The mounting clips can be combined and adjusted individually. Attached to a mounting base the assembly can be screw mounted or adhered to the surface.

Features and benefits

- Mounts and routes Helawrap cable cover flexibly and efficiently
- Fit snugly around the cable cover and holds it tight
- Each clip can be joined to mounting plate or other clips of any size
- Each clip rotates freely
- Easily released and re-used
- Mounting plates fixed with screws, cable ties or adhesive



The Helawrap accessory set for bundling, fixing and protecting multiple cable runs.

MATERIAL	Polyamide 6.6, high impact modified, heat stabilised (PA66HIRHS)	Flexible Polyvinyl Chloride, cadmium free (PVC)
Operating Temperature	-40 °C to +105 °C, (+105 °C for 500 h)	-35 °C to +50 °C
Flammability	UL 94 HB	UL 94 V2

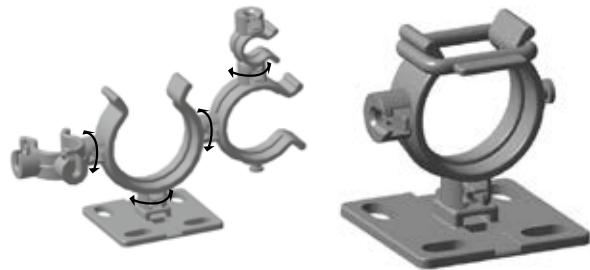

Multiple clips can be joined. Clips swivel freely.

For secure hold, R1 loop can be used (for HWClip25 and HWClip30 only).

TYPE	for Helawrap size	Material	Colour	Pack Cont.	Article-No.
HWCLIP08	8	PA66HIRHS	Black (BK)	50 pcs.	161-64002
HWCLIP16	16	PA66HIRHS	Black (BK)	50 pcs.	161-64004
HWCLIP20	20	PA66HIRHS	Black (BK)	50 pcs.	161-64006
HWCLIP25	25	PA66HIRHS	Black (BK)	50 pcs.	161-64008
HWCLIP30	30	PA66HIRHS	Black (BK)	50 pcs.	161-64010
R1	25, 30	PVC	Black (BK)	500 pcs.	201-20010

Subject to technical changes.

HWBase

Features and benefits

- Mounting plates can be fixed with screws, cable ties or adhesive
- Can be used to mount any size HWClip

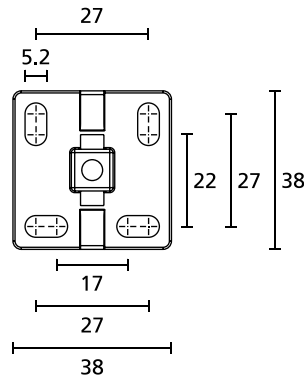

Helawrap HWBase/HWBaseA

TYPE	Adhesive	Colour	Pack Cont.	Article-No.
HWBASE	-	Black (BK)	50 pcs.	161-64015
HWBASEA	Acrylate with base of polyurethane foam	Black (BK)	50 pcs.	161-64013

Subject to technical changes.



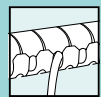

Application Tools for Helawrap Cable Cover

HAT Tools

The HAT application tools are used with Helawrap HWPP, HWPAVO and HWPPMC cable covers to bundle and protect cables rapidly and efficiently. There is a specially designed HAT application tool for each size Helawrap cable cover.

Features and benefits

- Bundle cable rapidly and effortlessly
- Glides smoothly and securely through cover
- Easy insertion of cable



Applicator tools HAT are available for every Helawrap cover size.

TYPE	Colour	Pack Cont.	Article-No.
HAT8	Blue (BU)	10 pcs.	161-60001
HAT16	Blue (BU)	10 pcs.	161-60002
HAT20	Blue (BU)	10 pcs.	161-60003
HAT25	Blue (BU)	10 pcs.	161-60004
HAT30	Blue (BU)	10 pcs.	161-60005
HAT40	Blue (BU)	5 pcs.	161-60006

Subject to technical changes.
Minimum Order Quantity (MOQ) may differ from package content.



Add items to your watchlist!

www.HT.click/49-339





Standard Polyethylene Spiral Binding for general applications

SBPE

SBPE spiral binding is suitable for standard electrical applications and panel building and plant engineering. Sizes 4 and 9 are also available in practical 5 metre lengths.

Features and benefits

- Organises and protects cables and hoses
- Suitable for retro-fitting
- Cables branch out at any point
- Wide range of diameters and colours



Spiral binding SBPE.

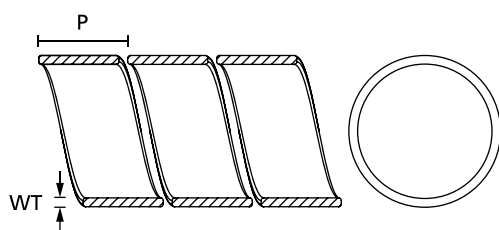

Spiral binding

MATERIAL	Polyethylene (PE)
Operating Temperature	-60 °C to +80 °C, intermittent +120 °C
Flammability	UL 94 HB



TYPE	Nominal Ø	Wall (WT)	Pitch (P)	Bundle Ø min.	Bundle Ø max.	Colour	Reel Length	Article-No.
SBPE1.5	1.5	0.8	6.0	1.6	8	Black (BK)	30 m	161-41001
	1.5	0.8	6.0	1.6	8	Grey (GY)	30 m	161-41002
	1.5	0.8	6.0	1.6	8	Natural (NA)	30 m	161-41000
SBPE4	4	1.0	7.8	5	20	Black (BK)	30 m	161-41101
	4	1.0	7.8	5	20	Grey (GY)	30 m	161-41102
	4	1.0	7.8	5	20	Natural (NA)	30 m	161-41100
SBPE6	6	1.2	10.0	7.5	40	Black (BK)	30 m	161-41151
	6	1.2	10.0	7.5	40	Grey (GY)	30 m	161-41154
	6	1.2	10.0	7.5	40	Natural (NA)	30 m	161-41150
SBPE9	9	1.4	12.5	10	100	Black (BK)	30 m	161-41201
	9	1.4	12.5	10	100	Grey (GY)	30 m	161-41202
	9	1.4	12.5	10	100	Natural (NA)	30 m	161-41200
SBPE16	16	1.6	16.0	20	150	Black (BK)	30 m	161-41301
	16	1.6	16.0	20	150	Grey (GY)	30 m	161-41302
	16	1.6	16.0	20	150	Natural (NA)	30 m	161-41300

All dimensions in mm. Subject to technical changes. Minimum Order Quantity (MOQ) may differ from package content.

TYPE	Nominal Ø	Wall (WT)	Pitch (P)	Bundle Ø min.	Bundle Ø max.	Colour	Reel Length	Article-No.
SBPE4D	4	1.0	7.8	5	20	Black (BK)	5 m	161-41104
	4	1.0	7.8	5	20	Grey (GY)	5 m	161-41105
	4	1.0	7.8	5	20	Natural (NA)	5 m	161-41103
SBPE6D	6	1.2	10.0	7.5	40	Black (BK)	5 m	161-41153
	6	1.2	10.0	7.5	40	Grey (GY)	5 m	161-41155
	6	1.2	10.0	7.5	40	Natural (NA)	5 m	161-41152
SBPE9D	9	1.4	12.5	10	100	Black (BK)	5 m	161-41204
	9	1.4	12.5	10	100	Grey (GY)	5 m	161-41205
	9	1.4	12.5	10	100	Natural (NA)	5 m	161-41203

All dimensions in mm. Subject to technical changes. Minimum Order Quantity (MOQ) may differ from package content.



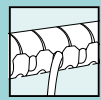

Polyethylene Spiral Binding for enhanced flame protection

SBPEFR

The flame-retardant properties of SBPEFR make it suitable for applications in the automobile and electrical industries, where enhanced fire protection is needed.

Features and benefits

- Organises and protects cables and hoses
- Self-extinguishing according to UL94 V2
- Suitable for retro-fitting
- Cables branch out at any point
- Wide range of diameters and colours



Spiral binding SBPEFR is available in a wide range of diameters and in colours black and white.

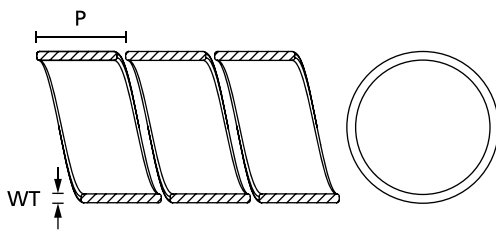

Spiral binding

MATERIAL	Polyethylene (PEFR), Flame retardant
Operating Temperature	-60 °C to +80 °C, intermittent +120 °C
Flammability	UL 94 V2, FMVSS 302, Type B



TYPE	Nominal Ø	Wall (WT)	Pitch (P)	Bundle Ø min.	Bundle Ø max.	Colour	Reel Length	Article-No.
SBPEFR1.5	1.5	0.8	6.0	1.6	8	Black (BK)	30 m	161-43001
	1.5	0.8	6.0	1.6	8	White (WH)	30 m	161-43000
SBPEFR4	4	1.0	7.8	5	20	Black (BK)	30 m	161-43101
	4	1.0	7.8	5	20	White (WH)	30 m	161-43100
SBPEFR6	6.0	0.8	10.0	7.5	40.0	Black (BK)	30 m	161-43151
	6.0	0.8	10.0	7.5	40.0	White (WH)	30 m	161-43150
SBPEFR9	9	1.4	12.5	10	100	Black (BK)	30 m	161-43201
	9	1.4	12.5	10	100	White (WH)	30 m	161-43200
SBPEFR16	16	1.6	16.0	20	150	Black (BK)	30 m	161-43301
	16	1.6	16.0	20	150	White (WH)	30 m	161-43300

All dimensions in mm. Subject to technical changes. Minimum Order Quantity (MOQ) may differ from package content.



Add items to your watchlist!

www.HT.click/49-341





Polyamide Spiral Binding for added strength and protection against abrasion

SBPA

SBPA spiral binding is used for cable harnesses in the automobile industry and for many demanding industrial applications.

Features and benefits

- Organises and protects cables and hoses
- Very good protection against abrasion
- Suitable for retro-fitting
- Cables branch out at any point
- Wide range of diameters and colours



SBPA spiral binding made of polyamide offers excellent protection against abrasion.

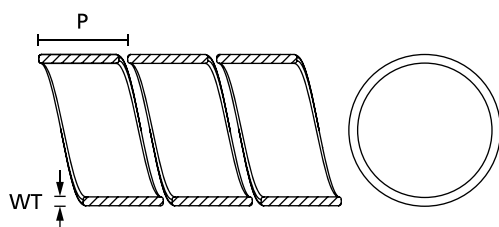

Spiral binding

MATERIAL	Polyamide 6 (PA6)
Operating Temperature	-60 °C to +95 °C
Flammability	UL 94 HB

HF ✓

RoHS ✓

TYPE	Nominal Ø	Wall (WT)	Pitch (P)	Bundle Ø min.	Bundle Ø max.	Colour	Reel Length	Article-No.
SBPA1.5	1.5	0.4	6.0	1.6	8	Natural (NA)	30 m	161-42000
SBPA4	4	0.6	7.8	5	20	Natural (NA)	30 m	161-42100
SBPA6	6	0.8	10.0	7.5	40	Natural (NA)	30 m	161-42150
SBPA9	9	1.0	12.5	10	100	Natural (NA)	30 m	161-42200
SBPA16	16	1.2	16.0	20	150	Natural (NA)	30 m	161-42300

All dimensions in mm. Subject to technical changes.
Minimum Order Quantity (MOQ) may differ from package content.



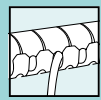

Polyethylene Spiral Binding with UL94V0 classification

SBPAV0

Due to its excellent flame protection properties, SBPAV0 spiral binding is particularly suitable for the rail and aviation industries as well as public buildings.

Features and benefits

- Organises and protects cables and hoses
- Self-extinguishing according to UL94 V0
- Very good protection against abrasion
- Suitable for retro-fitting
- Cables branch out at any point
- Wide range of diameters



Spiral binding SBPAV0.

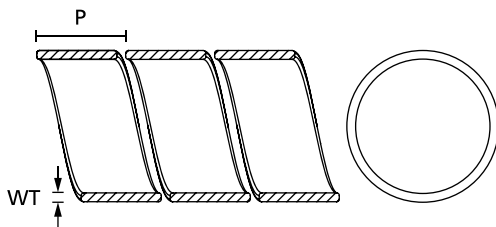

Spiral binding

MATERIAL	Polyamide 6 V0 (PA6V0)
Operating Temperature	-40 °C to +95 °C, intermittent +130 °C
Flammability	UL 94 V0
EN 45545-2 Classification	R22 HL2, R23 HL2



TYPE	Nominal Ø	Wall (WT)	Pitch (P)	Bundle Ø min.	Bundle Ø max.	Colour	Reel Length	Article-No.
SBPAV01.5	1.5	0.4	6.0	1.6	8	Black (BK)	30 m	161-44000
SBPAV04	4	0.6	7.8	5	20	Black (BK)	30 m	161-44100
SBPAV06	6	0.8	10.0	7.5	40	Black (BK)	30 m	161-44150
SBPAV09	9	1.0	12.5	10	100	Black (BK)	30 m	161-44200
SBPAV016	16	1.2	16.0	20	150	Black (BK)	30 m	161-44300

All dimensions in mm. Subject to technical changes.
Minimum Order Quantity (MOQ) may differ from package content.

EN 45545-2

For product specific approvals and specifications please refer to the Appendix.



Add items to your watchlist!

www.HT.click/49-343





PTFE Spiral Binding for superior protection

SBPTFE

Wherever superior protection against chemical and extreme temperatures are important, the use of SBPTFE is recommended.

Features and benefits

- High temperature resistance
- Excellent fire protection
- Self-extinguishing according to UL94 V0
- Very good solvent and acid resistance
- Organises and protects cables and hoses
- Suitable for retro-fitting
- Cables branch out at any point



Spiral binding SBTFE - ideal for extreme conditions.

MATERIAL	Polytetrafluoroethylene (PTFE)
Operating Temperature	-60 °C to +260 °C, intermittent +350 °C
Flammability	UL 94 V0

RoHS ✓

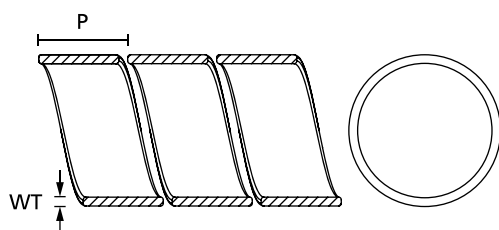

Spiral binding

TYPE	Nominal Ø	Wall (WT)	Pitch (P)	Bundle Ø min.	Bundle Ø max.	Colour	Reel Length	Article-No.
SBPTFE1.5	1.5	0.5	6.0	1.6	8	Natural (NA)	5 m	161-45000
SBPTFE4	4	0.7	7.8	5	20	Natural (NA)	5 m	161-45100
SBPTFE9	9	1.0	12.5	10	100	Natural (NA)	5 m	161-45200

All dimensions in mm. Subject to technical changes.
Minimum Order Quantity (MOQ) may differ from package content.



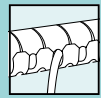

PE Metal Detectable Spiral Binding

SBPEMC

SBPEMC is designed for applications in food-processing plants and machines.

Features and benefits

- High metal-content for reliable detection with standard detection equipment
- Stainless steel preserves resistance to corrosion
- Blue colour for enhanced visibility
- Ideal solution for bundling and protecting cables and hoses
- Highly flexible
- Suitable for retro-fitting
- Branching off cable at any point



Detectable, metal-content spiral binding protects cables on food-processing machines.

MATERIAL	Polyethylene (PE), Stainless Steel (SS)
Operating Temperature	-60 °C to +80 °C, intermittent +120 °C
Flammability	UL 94 HB

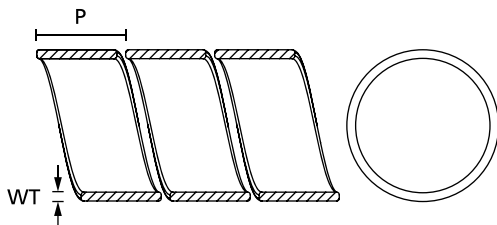

Spiral binding



Can support quality assurance in the production of food stuffs, for example HACCP.

TYPE	Nominal Ø	Wall (WT)	Pitch (P)	Bundle Ø min.	Bundle Ø max.	Colour	Reel Length	Article-No.
SBPEMC1.5	1.5	0.8	6.0	1.6	8	Blue (BU)	30 m	161-46000
SBPEMC4	4	1.0	7.8	5	20	Blue (BU)	30 m	161-46100
SBPEMC9	9	1.4	12.5	10	100	Blue (BU)	30 m	161-46200
SBPEMC16	16	1.6	16.0	20	150	Blue (BU)	30 m	161-46300

All dimensions in mm. Subject to technical changes.
Minimum Order Quantity (MOQ) may differ from package content.



Add items to your watchlist!

www.HT.click/49-345





PP High Abrasion-resistant Narrow Pitch Spiral Binding

SBPPHDR

Spiral binding is used to route and bind cables that need high mechanical protection, for instance in the automotive industry as well as in control panels and cabinets. It is also used in electrical installation, where safety is a primary consideration. Spiral binding provides a tidy solution for many applications.

Features and benefits

- For organising and protecting cables and hoses
- Heavy-walled and very robust
- Excellent protection from mechanical stress
- Very high abrasion resistance
- Very good resistance to oils
- Available in diameters up to 50 mm
- Ideal for larger cable bundles



More colours and sizes available on request.

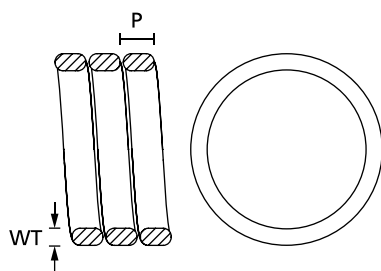

Spiral binding



SBPPHDR - Heavy Duty Round Spiral Wrap.

MATERIAL	Polypropylene (PP)
Operating Temperature	-30 °C to +100 °C
Flammability	UL 94 HB

HF ✓

RoHS ✓

TYPE	Nominal Ø	Wall (WT)	Pitch (P)	Bundle Ø min.	Bundle Ø max.	Colour	Length (L)	Article-No.
SBPPHDR10	10	2.0	5.0	10	14	Black (BK)	1.0 m	162-30000
SBPPHDR15	15	2.5	5.0	15	20	Black (BK)	1.0 m	162-30100
SBPPHDR20	20	2.5	5.5	20	25	Black (BK)	1.0 m	162-30200
SBPPHDR25	25	2.5	6.0	25	30	Black (BK)	1.0 m	162-30300
SBPPHDR30	30	3.5	6.5	30	37	Black (BK)	1.0 m	162-30400
SBPPHDR35	35	3.5	6.5	35	42	Black (BK)	1.0 m	162-30500
SBPPHDR40	40	4.0	7.0	40	48	Black (BK)	1.0 m	162-30600
SBPPHDR50	50	4.5	8.0	50	59	Black (BK)	1.0 m	162-30700

All dimensions in mm. Subject to technical changes.
Minimum Order Quantity (MOQ) may differ from package content.



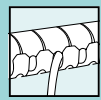

PP High Abrasion-resistant Wide Pitch Spiral Binding

SBPPHDF

SBPPHDF spiral binding is especially suitable wherever high abrasion resistance and much larger cable diameters are needed, for example in the petrochemical industry and in plant construction.

Features and benefits

- For organising and protecting cables and hoses
- Heavy-walled and very robust
- Excellent protection from mechanical stress
- Very high abrasion resistance
- Very good resistance to oils
- Available in diameters up to 50 mm
- Ideal for larger cable bundles



SBPPHDF - Heavy Duty Flat Spiral Wrap.

MATERIAL	Polypropylene (PP)
Operating Temperature	-30 °C to +100 °C
Flammability	UL 94 HB



More colours and sizes available on request.

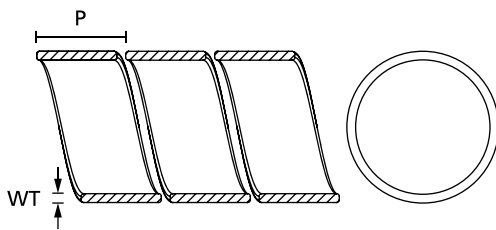

Spiral binding

TYPE	Nominal Ø	Wall (WT)	Pitch (P)	Bundle Ø min.	Bundle Ø max.	Colour	Length (L)	Article-No.
SBPPHDF10	10	1.5	10	10	13	Black (BK)	1.0 m	162-31000
SBPPHDF15	15	1.5	13	15	18	Black (BK)	1.0 m	162-31100
SBPPHDF20	20	1.5	18	20	23	Black (BK)	1.0 m	162-31200
SBPPHDF25	25	2.0	19	25	29	Black (BK)	1.0 m	162-31300
SBPPHDF30	30	2.0	20	30	34	Black (BK)	1.0 m	162-31400
SBPPHDF35	35	2.0	20	35	39	Black (BK)	1.0 m	162-31500
SBPPHDF40	40	2.5	20	40	45	Black (BK)	1.0 m	162-31600
SBPPHDF50	50	3.0	22	50	56	Black (BK)	1.0 m	162-31700

All dimensions in mm. Subject to technical changes.
Minimum Order Quantity (MOQ) may differ from package content.



Add items to your watchlist!

www.HT.click/49-347





Standard polyester braided sleeving

Helagaine HEGP

Helagaine HEGP braided sleeving is used in the automotive industry and in machine construction. It is also used for smaller electrical appliances to avoid pockets of high temperature. HEGP fulfils the strict requirement of DIN5510-2 and is therefore also optimal for railway applications.

Features and benefits

- Made of sturdy polyester
- Highly flexible
- High abrasion resistance
- Very high surface coverage
- 13 sizes for diameters from 1 - 66 mm for an optimal fit



Helagaine HEGP braided sleeving.

MATERIAL	Polyester (PET)
Operating Temperature	-50 °C to +150 °C
Melting Point	+250 °C
Flammability	UL 94 V2, FMVSS 302
EN 45545-2 Classification	R22 HL3, R23 HL3



TYPE	Bundle Ø min.	Bundle Ø max.	Colour	Reel Length	Tools	Article-No.
HEGP03	1	5	Black (BK)	200 m	45	170-10300
HEGP04	2	7	Black (BK)	200 m	45	170-10400
HEGP05	3	9	Black (BK)	200 m	45	170-10500
HEGP06	4	11	Black (BK)	100 m	45	170-10600
HEGP08	5	12	Black (BK)	100 m	45	170-10800
HEGP10	7	15	Black (BK)	100 m	45	170-11000
HEGP12	8	17	Black (BK)	100 m	45	170-11200
HEGP15	10	20	Black (BK)	100 m	45	170-11500
HEGP20	14	26	Black (BK)	50 m	45	170-12000
HEGP25	18	34	Black (BK)	50 m	45	170-12500
HEGP30	20	40	Black (BK)	50 m	45	170-13000
HEGP40	30	50	Black (BK)	50 m	45	170-14000
HEGP50	40	66	Black (BK)	50 m	45	170-15000

All dimensions in mm. Subject to technical changes.

Colour grey available on request. Cuts in any lengths. Minimum Order Quantity (MOQ) may differ from package content.

Recommended Tools	
	45 HSG0
	570

For more information on toolings please refer to the Application Tooling chapter.

EN 45545-2

ECE R-118

For product specific approvals and specifications please refer to the Appendix.



Add items to your watchlist!

www.HT.click/49-348



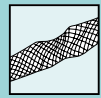

Standard polyester braided sleeving, expansion rate: 3:1

Helagain HEGPX

Helagain HEGPX is used whenever a higher expansion rate is required. HEGPX is particularly suitable for use in the automotive industry, panel building and in electrical appliances.

Features and benefits

- Made of sturdy polyester
- Highly flexible
- High rate of expansion
- Easy to apply over irregular shapes
- Good abrasion resistance



HEGPX - Expandable abrasion protection sleeve.

MATERIAL	Polyester (PET)
Operating Temperature	-50 °C to +150 °C
Melting Point	+250 °C
Flammability	UL 94 V2, FMVSS 302
EN 45545-2 Classification	R22 HL2, R23 HL2



TYPE	Bundle Ø min.	Bundle Ø max.	Colour	Reel Length	Tools	Article-No.
HEGPX06	3	9	Black (BK)	200 m	45	170-00060
HEGPX09	5	16	Black (BK)	100 m	45	170-00090
HEGPX12	6	19	Black (BK)	100 m	45	170-00120
HEGPX20	12	32	Black (BK)	100 m	45	170-00200
HEGPX30	19	45	Black (BK)	50 m	45	170-00300
HEGPX40	32	70	Black (BK)	50 m	45	170-00400

All dimensions in mm. Subject to technical changes.

Colour grey available on request. Cuts in any lengths. Minimum Order Quantity (MOQ) may differ from package content.

Recommended Tools	
	45 HSG0
	570

For more information on toolings please refer to the Application Tooling chapter.

EN 45545-2



For product specific approvals and specifications please refer to the Appendix.



Add items to your watchlist!

www.HT.click/49-349





Flame-retardant polyester braided sleeving

Helagain HEGPETFR

This sleeve is particularly designed for abrasion protection of bundles of electrical cables. Helagain HEGPETFR is therefore particularly recommended in applications such as public transport, aircraft industry, telecommunications, underground cables, etc.

Features and benefits

- Made of sturdy polyester
- Self-extinguishing
- Highly flexible
- Easy to apply over irregular shapes
- Good abrasion resistance



Helagain HEGPETFR braided sleeving.

MATERIAL	Polyester (PET)
Operating Temperature	-50 °C to +150 °C
Melting Point	+250 °C
Flammability	FMVSS 302, Type B, UL 1441 VW-1



TYPE	Bundle Ø min.	Bundle Ø max.	Colour	Reel Length	Tools	Article-No.
HEGPETFR04	3	7	Black with Grey Identification Yarn (BKIDGY)	200 m	45	170-81001
HEGPETFR05	4	9	Black with Grey Identification Yarn (BKIDGY)	200 m	45	170-81002
HEGPETFR06	5	11	Black with Grey Identification Yarn (BKIDGY)	100 m	45	170-81003
HEGPETFR08	7	13	Black with Grey Identification Yarn (BKIDGY)	100 m	45	170-81004
HEGPETFR10	9	15	Black with Grey Identification Yarn (BKIDGY)	100 m	45	170-81005
HEGPETFR12	11	17	Black with Grey Identification Yarn (BKIDGY)	100 m	45	170-81006
HEGPETFR15	13	20	Black with Grey Identification Yarn (BKIDGY)	100 m	45	170-81007
HEGPETFR20	18	25	Black with Grey Identification Yarn (BKIDGY)	50 m	45	170-81008
HEGPETFR25	22	30	Black with Grey Identification Yarn (BKIDGY)	50 m	45	170-81009
HEGPETFR30	27	40	Black with Grey Identification Yarn (BKIDGY)	50 m	45	170-81010
HEGPETFR40	35	50	Black with Grey Identification Yarn (BKIDGY)	50 m	45	170-81011
HEGPETFR50	45	60	Black with Grey Identification Yarn (BKIDGY)	50 m	45	170-81012

All dimensions in mm. Subject to technical changes.

Recommended Tools	
	45 HSG0
	570

For more information on toolings please refer to the Application Tooling chapter.

EN 45545-2



For product specific approvals and specifications please refer to the Appendix.



Add items to your watchlist!

www.HT.click/49-350



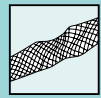

Flame-retardant, high-expansion polyester braided sleeving

Helagaine HEGPETFRX

Helagaine HEGPETFRX is especially suitable for areas wherever fire protection is important as well as a higher expansion ratio of the braided sleeve. Helagaine HEGPETFRX offers superior cable protection for machine tools, robotics and automatic equipment.

Features and benefits

- Made of sturdy polyester
- Self-extinguishing
- Highly flexible
- High rate of expansion
- Easy to apply over irregular shapes
- Good abrasion resistance



Helagaine HEGPETFRX.

MATERIAL	Polyester (PET)
Operating Temperature	-50 °C to +150 °C
Melting Point	+250 °C
Flammability	FMVSS 302, Type B, UL 1441 VW-1



TYPE	Bundle Ø min.	Bundle Ø max.	Colour	Reel Length	Tools	Article-No.
HEGPETFRX03	2	6	Black with Grey Identification Yarn (BKIDGY)	200 m	45	170-81100
HEGPETFRX06	3	10	Black with Grey Identification Yarn (BKIDGY)	200 m	45	170-81101
HEGPETFRX09	5	16	Black with Grey Identification Yarn (BKIDGY)	100 m	45	170-81102
HEGPETFRX12	6	19	Black with Grey Identification Yarn (BKIDGY)	100 m	45	170-81103
HEGPETFRX20	12	32	Black with Grey Identification Yarn (BKIDGY)	100 m	45	170-81104
HEGPETFRX30	19	45	Black with Grey Identification Yarn (BKIDGY)	50 m	45	170-81105
HEGPETFRX40	32	70	Black with Grey Identification Yarn (BKIDGY)	50 m	45	170-81106
HEGPETFRX50	38	76	Black with Grey Identification Yarn (BKIDGY)	50 m	45	170-81107

All dimensions in mm. Subject to technical changes.

Recommended Tools	
	45 HSG0
	570

For more information on toolings please refer to the Application Tooling chapter.



For product specific approvals and specifications please refer to the Appendix.



Add items to your watchlist!

www.HT.click/49-351





Polyamide braided sleeving for excellent abrasion resistance

Helagaine HEGPA66

Helagaine HEGPA66 is particularly suitable for vehicle manufacturing as well as plant construction.

Features and benefits

- Made from heavy-duty polyamide yarn
- Excellent abrasion resistance
- Highly flexible
- Easy to apply over irregular shapes
- Eases application by expanding when compressed
- Very high surface covering



Various types of Helagaine braided sleeving.

MATERIAL	Polyamide 6.6 (PA66)
Operating Temperature	-60 °C to +150 °C
Melting Point	+255 °C
Flammability	UL 94 V2, FMVSS 302
EN 45545-2 Classification	R22 HL3, R23 HL3



TYPE	Bundle Ø min.	Bundle Ø max.	Colour	Reel Length	Tools	Article-No.
HEGPA6604	3	6	Black (BK)	200 m	45	170-40400
HEGPA6606	4	8	Black (BK)	100 m	45	170-40600
HEGPA6608	5	10	Black (BK)	100 m	45	170-40800
HEGPA6610	7	12	Black (BK)	100 m	45	170-41000
HEGPA6612	8	14	Black (BK)	100 m	45	170-41200
HEGPA6616	12	18	Black (BK)	50 m	45	170-41600
HEGPA6620	15	23	Black (BK)	50 m	45	170-42000
HEGPA6625	18	28	Black (BK)	50 m	45	170-42500
HEGPA6630	25	32	Black (BK)	50 m	45	170-43000
HEGPA6640	30	44	Black (BK)	50 m	45	170-44000
HEGPA6650	40	55	Black (BK)	50 m	45	170-45000
HEGPA6660	50	65	Black (BK)	50 m	45	170-46000

All dimensions in mm. Subject to technical changes.

Colour grey available on request. Cuts in any lengths. Minimum Order Quantity (MOQ) may differ from package content.

Recommended Tools	
	45 HSG0
	570

For more information on toolings please refer to the Application Tooling chapter.

EN 45545-2

ECE R-118

For product specific approvals and specifications please refer to the Appendix.



Add items to your watchlist!

www.HT.click/49-352



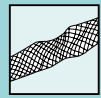

Light weight standard polyester braided sleeving

Helagaine HEGPL

Helagaine HEGPL is used primarily in automobile interiors, motor compartments, car bodies and underfloors.

Features and benefits

- Made of sturdy polyester
- Expansion rate of 3:1
- Easier application over irregular shapes
- Highly flexible
- Good abrasion resistance



Helagaine HEGPL braided sleeving.

MATERIAL	Polyester (PET)
Operating Temperature	-50 °C to +150 °C
Melting Point	+250 °C
Flammability	UL 94 V2, FMVSS 302, Type B



TYPE	Bundle Ø min.	Bundle Ø max.	Colour	Reel Length	Tools	Article-No.
HEGPL03	3	8	Black (BK)	1,000 m	45	170-80503
HEGPL06	5	12	Black (BK)	400 m	45	170-80506
HEGPL12	8	21	Black (BK)	300 m	45	170-80512
HEGPL20	12	30	Black (BK)	300 m	45	170-80520
HEGPL30	18	55	Black (BK)	200 m	45	170-80530
HEGPL40	24	66	Black (BK)	150 m	45	170-80540
HEGPL50	30	82	Black (BK)	150 m	45	170-80550

All dimensions in mm. Subject to technical changes.

Colour grey available on request. Cuts in any lengths. Minimum Order Quantity (MOQ) may differ from package content.

Recommended Tools	
	45 HSG0
	570

For more information on toolings please refer to the Application Tooling chapter.



Add items to your watchlist!

www.HT.click/49-353





Standard braided sleeving in dispenser boxes

Helagaine HLB

Helagaine HLB is supplied in practical dispenser boxes and covers a wide range of applications with only a few sizes. It is ideal for both the professional and the home user. Helagaine HLB bundles and effectively protects cables and wires, for instance in HiFi systems and in industrial plants. Helagaine HLB also provides good resistance to abrasion.

Features and benefits

- In practical, space-saving 10 m dispenser boxes
- Expands to 3x nominal diameter
- Bundling diameters from 5 mm to 54 mm
- Three sizes for very wide range of applications
- Extraction of sleeves



Helagaine HLB: The expansion rate makes it possible. Only three sizes in a handy dispenser box for almost all standard diameters.

MATERIAL	Polyester (PET)
Operating Temperature	-50 °C to +150 °C, intermittent +220 °C
Melting Point	+250 °C
Flammability	UL 94 V2



TYPE	Ø (D)	Bundle Ø min.	Bundle Ø max.	Colour	Reel Length	Tools	Article-No.
HLB15	15	5	21	Black (BK)	10 m	45	170-80150
HLB25	25	10	30	Black (BK)	10 m	45	170-80250
HLB35	35	18	54	Black (BK)	10 m	45	170-80350

All dimensions in mm. Subject to technical changes.

Recommended Tools	
	45 HSG0
	570

For more information on toolings please refer to the Application Tooling chapter.



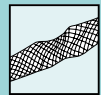

Meta-aramid braided sleeving

Helagaine HEGMAN

Helagaine HEGMAN provides excellent mechanical protection for applications involving high temperatures and fire-protection, particularly in the aerospace, military, railway and ship-building industries.

Features and benefits

- Made of non-flammable meta-aramid
- Extremely flexible
- High expansion for easy installation over long lengths
- Optimal mechanical protection for harnesses
- Able to withstand the most severe environments
- Superior protection against abrasion, flames and high temperatures
- Highly resistant to radiation and fluids



Helagaine HEGMAN braided sleeving.

MATERIAL	Polyaramid Polymetaphenylene Isophthalamide (PMPI)
Operating Temperature	-60 °C to +240 °C
Melting Point	Does not melt / Carbonisation above +370 °C
Flammability	UL 94 V0 (Raw material), UL 224 VV-1

RoHS ✓

TYPE	Bundle Ø min.	Bundle Ø max.	Colour	Reel Length	Article-No.
HEGMAN-02	1	2	Green (GN)	100 m	170-02100
HEGMAN-04	2	4	Green (GN)	100 m	170-02101
HEGMAN-06	4	8	Green (GN)	100 m	170-02102
HEGMAN-08	6	12	Green (GN)	50 m	170-02103
HEGMAN-10	8	16	Green (GN)	50 m	170-02104
HEGMAN-15	10	20	Green (GN)	50 m	170-02105
HEGMAN-20	12	24	Green (GN)	50 m	170-02106
HEGMAN-25	15	30	Green (GN)	50 m	170-02107
HEGMAN-30	20	40	Green (GN)	50 m	170-02108

All dimensions in mm. Subject to technical changes.

Cuts in any lengths. NOMEX® is a registered trademark of DuPont. Minimum Order Quantity (MOQ) may differ from package content.



Add items to your watchlist!

www.HT.click/49-355





Water and oil repellent meta-aramid braided sleeving

Helagaine HEGMANWO

Helagaine HEGMANWO is especially resistant to water and oil and is designed for applications requiring mechanical protection at high temperatures, particularly in the aerospace, military, railway and ship-building industries.

Features and benefits

- Made of non-flammable meta-aramid
- Water and oil-repellent
- Extremely flexible
- High expansion for easy installation over long lengths
- Optimal mechanical protection for harnesses
- Able to withstand the most severe environments
- Superior protection against abrasion, flames and high temperatures
- Highly resistant to radiation, microorganisms and fluids
- Also very resistant to acids and alkali



Helagaine HEGMANWO braided sleeving.

MATERIAL	Polyaramid Polymetaphenylene Isophthalamide (PMPI)
Operating Temperature	-60 °C to +240 °C
Melting Point	Does not melt / Carbonisation above +370 °C
Flammability	UL 94 V0 (Raw material), UL 224 VV-1

RoHS

TYPE	Bundle Ø min.	Bundle Ø max.	Colour	Reel Length	Article-No.
HEGMANWO-02	1	2	Green (GN)	100 m	170-02000
HEGMANWO-04	2	4	Green (GN)	100 m	170-02001
HEGMANWO-06	4	8	Green (GN)	100 m	170-02002
HEGMANWO-08	6	12	Green (GN)	50 m	170-02003
HEGMANWO-10	8	16	Green (GN)	50 m	170-02004
HEGMANWO-15	10	20	Green (GN)	50 m	170-02005
HEGMANWO-20	12	24	Green (GN)	50 m	170-02006
HEGMANWO-25	15	30	Green (GN)	50 m	170-02007
HEGMANWO-30	20	40	Green (GN)	50 m	170-02008

All dimensions in mm. Subject to technical changes.

Cuts in any lengths. NOMEX® is a registered trademark of DuPont. Minimum Order Quantity (MOQ) may differ from package content.



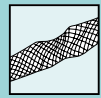

Polyester self-closing sleeving

Helagaine Twist-In

Helagaine Twist-In is used to bundle and protect pre-terminated cables in machine-building and automation, electrical installations and automobile and truck manufacturing.

Helagaine Twist-In is also available in practical 2 m and 5 m lengths for use in the home or office.

Features and benefits

- Self-closing sleeve made of polyester
- Very good protection against abrasion
- Ideal for retro-fitting
- Quick and easy installation and removal
- Allows to bundle for inspection, maintenance and assembly
- Small range of sizes covers a wide range of applications



Helagaine Twist-In enables easy access to cables and wires for assembly, inspection and maintenance.



www.HellermannTyton.co.uk/Twist-In-cat22

MATERIAL	Polyester (PET)
Operating Temperature	-50 °C to +125 °C
Melting Point	+255 °C
Flammability	self-extinguishing, FMVSS 302



TYPE	Bundle Ø min.	Bundle Ø max.	Colour	Reel Length	Tools	Article-No.
Twist-In 05	4	5	Black (BK)	150 m	45	170-01000
Twist-In 08	5	8	Black (BK)	100 m	45	170-01001
Twist-In 13	10	13	Black (BK)	50 m	45	170-01002
Twist-In 19	16	19	Black (BK)	25 m	45	170-01004
Twist-In 25	19	25	Black (BK)	25 m	45	170-01005
Twist-In 29	25	29	Black (BK)	15 m	45	170-01006
Twist-In 32	29	32	Black (BK)	15 m	45	170-01007
Twist-In 38	32	38	Black (BK)	15 m	45	170-01008
Twist-In 50	38	50	Black (BK)	15 m	45	170-01010

All dimensions in mm. Subject to technical changes. Minimum Order Quantity (MOQ) may differ from package content.

TYPE	Bundle Ø min.	Bundle Ø max.	Colour	Reel Length	Tools	Article-No.
Twist-In 05-5 m	4	5	Black (BK)	5 m	45	170-01011
Twist-In 08-5 m	5	8	Black (BK)	5 m	45	170-01012
Twist-In 13-5 m	10	13	Black (BK)	5 m	45	170-01013
Twist-In 19-2 m	16	19	Black (BK)	2 m	45	170-01014
Twist-In 25-2 m	19	25	Black (BK)	2 m	45	170-01015
Twist-In 29-2 m	25	29	Black (BK)	2 m	45	170-01016
Twist-In 32-2 m	29	32	Black (BK)	2 m	45	170-01017
Twist-In 38-2 m	32	38	Black (BK)	2 m	45	170-01018

All dimensions in mm. Subject to technical changes. Minimum Order Quantity (MOQ) may differ from package content.

Recommended Tools	
	45 HSG0
	570

For more information on toolings please refer to the Application Tooling chapter.



For product specific approvals and specifications please refer to the Appendix.



Add items to your watchlist!

www.HT.click/49-357



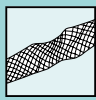

Polyester self-closing sleeving, flame-retardant

Helagaine Twist-In-FR

Helagaine Twist-In-FR can be used in areas where fire protection is important, such as railway, aerospace and shipbuilding.

Features and benefits

- Self-closing sleeve made from polyester
- Optimal fire protection
- Ideal for retro-fitting
- Very easy, quick installation and removal
- Quick and easy access to bundle for inspection, maintenance and assembly
- Small range of sizes covers a wide range of applications

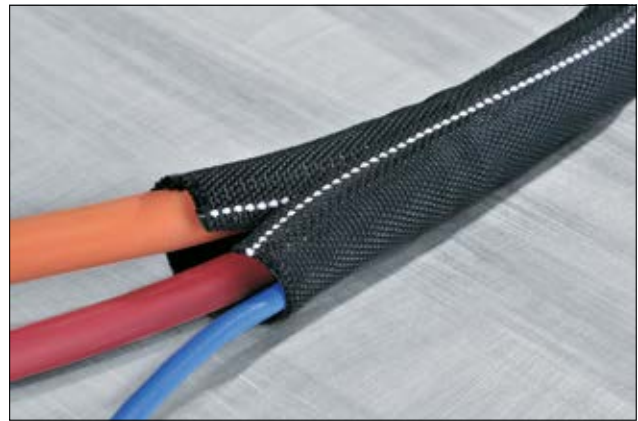

Helagaine Twist-In-FRX with the white identification yarn.

MATERIAL	Polyester (PET)
Operating Temperature	-50 °C to +125 °C
Melting Point	+240 °C
Flammability	FMVSS 302, self-extinguishing
EN 45545-2 Classification	R22 HL3, R23 HL3



TYPE	Bundle Ø min.	Bundle Ø max.	Colour	Reel Length	Tools	Article-No.
Twist-In-FR 05	4	5	Black with White Identification Yarn (BKIDWH)	150 m	45	170-01100
Twist-In-FR 08	5	8	Black with White Identification Yarn (BKIDWH)	100 m	45	170-01101
Twist-In-FR 13	10	13	Black with White Identification Yarn (BKIDWH)	50 m	45	170-01102
Twist-In-FR 19	16	19	Black with White Identification Yarn (BKIDWH)	25 m	45	170-01104
Twist-In-FR 25	19	25	Black with White Identification Yarn (BKIDWH)	25 m	45	170-01105
Twist-In-FR 29	25	29	Black with White Identification Yarn (BKIDWH)	15 m	45	170-01106
Twist-In-FR 32	29	32	Black with White Identification Yarn (BKIDWH)	15 m	45	170-01107
Twist-In-FR 38	32	38	Black with White Identification Yarn (BKIDWH)	15 m	45	170-01108
Twist-In-FR 50	38	50	Black with White Identification Yarn (BKIDWH)	15 m	45	170-01109

All dimensions in mm. Subject to technical changes.
Minimum Order Quantity (MOQ) may differ from package content.

Recommended Tools	
	45 HSG0
	570

For more information on toolings please refer to the Application Tooling chapter.

EN 45545-2

ECE R-118



For product specific approvals and specifications please refer to the Appendix.



Add items to your watchlist!

www.HT.click/49-358





Re-sealable protective sleeving for post-termination cable organisation

HELAAHOOK

HELAAHOOK is used in industrial machines, electrical appliances, shipbuilding, railway vehicles and in the aerospace industry. HELAAHOOK is also employed in automobiles or commercial vehicles. It is the ideal solution for post-termination cable organisation and wherever repeated use is a necessity.

Features and benefits

- Re-sealable cable protection made of polyester
- Very elastic, fits snugly around the cables
- Hook and loop sealing system can be used for retro-fitting
- High abrasion-resistance

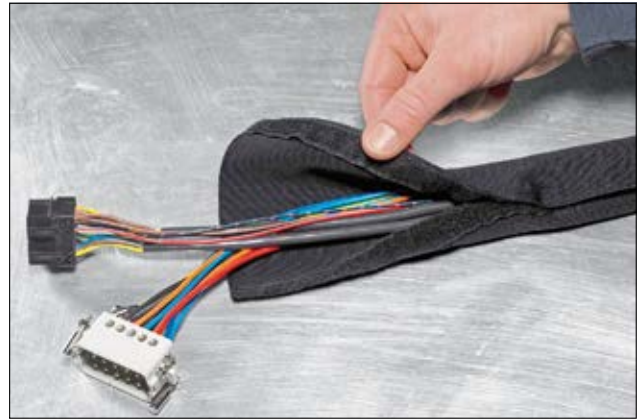

HELAAHOOK protective sleeving allows for retrospective fitting and repeated use.

MATERIAL	Polyester (PET)
Operating Temperature	-50 °C to +150 °C
Flammability	UL 94 V2, FMVSS 302



TYPE	Bundle Ø min.	Bundle Ø max.	Colour	Reel Length	Article-No.
HELAAHOOK10	3	15	Black (BK)	25 m	170-05100
HELAAHOOK15	10	20	Black (BK)	25 m	170-05150
HELAAHOOK20	15	30	Black (BK)	25 m	170-05200
HELAAHOOK25	20	40	Black (BK)	25 m	170-05250
HELAAHOOK30	25	50	Black (BK)	25 m	170-05300

All dimensions in mm. Subject to technical changes.
Cuts in any lengths. Minimum Order Quantity (MOQ) may differ from package content.



Add items to your watchlist!

www.HT.click/49-359





Burst Protection Sleeving for Hydraulic Hoses

Helagain HEGWS

Helagain HEGWS is burst protection sleeve highly resistant to abrasion and tears. HEGWS is used to protect hydraulic hoses and prevent injuries due to leaks emitting high-pressure liquid jets. HEGWS is typically used with earth moving machinery and where there is high mechanical vibration.

Features and benefits

- Exceptional tear-resistance
- Very good protection against abrasion
- Optimal protection of hydraulic hoses
- Reduces risk of liquid-jet injuries
- Fulfills the standards of Earth Moving Machinery EN ISO 3457 and Mechanical Vibration and Shock EN 1299



Helagain HEGWS: The ideal protective sleeve for hydraulic hoses.

MATERIAL	Polyamide 6 (PA6)
Operating Temperature	-60 °C to +125 °C
Melting Point	+220 +/- 10 °C
Flammability	UL 94 V2, FMVSS 302, Type B

HF ✓

RoHS ✓

TYPE	Inside Ø (ID)	Wall (WT)	Colour	Reel Length	Tools	Article-No.
HEGWS20	12	1.1	Black (BK)	50 m	45	170-01300
HEGWS25	15	1.1	Black (BK)	50 m	45	170-01301
HEGWS30	19	1.1	Black (BK)	50 m	45	170-01302
HEGWS35	22	1.1	Black (BK)	50 m	45	170-01303
HEGWS40	25	1.1	Black (BK)	50 m	45	170-01304
HEGWS45	28	1.1	Black (BK)	50 m	45	170-01305
HEGWS50	31	1.1	Black (BK)	50 m	45	170-01306
HEGWS60	38	1.1	Black (BK)	50 m	45	170-01307
HEGWS70	44	1.1	Black (BK)	50 m	45	170-01308
HEGWS80	50	1.1	Black (BK)	50 m	45	170-01309
HEGWS90	57	1.1	Black (BK)	50 m	45	170-01310
HEGWS100	60	1.1	Black (BK)	50 m	45	170-01311
HEGWS115	70	1.1	Black (BK)	50 m	45	170-01312
HEGWS145	90	1.1	Black (BK)	50 m	45	170-01313
HEGWS176	110	1.1	Black (BK)	50 m	45	170-01314
HEGWS200	125	1.1	Black (BK)	50 m	45	170-01315

All dimensions in mm. Subject to technical changes.
Minimum Order Quantity (MOQ) may differ from package content.

Recommended Tools	
	45 HSG0
	570

For more information on toolings please refer to the Application Tooling chapter.



Add items to your watchlist!

www.HT.click/49-360



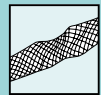

Electromagnetic protection braided sleeving

Helagaine HEGEMIP

Helagaine HEGEMIP braided sleeving is used for highly sensitive electronics, such as electrical appliances and machines, radio equipment, military and automotive engineering.

Features and benefits

- Excellent electromagnetic protection
- Extremely flexible, expandable and easy to apply
- Superior abrasion protection
- No kinks or tears, even when bending the sleeve 90°
- Particularly suitable for applications with restricted space or requiring movement
- Inner disposable tube protects sleeve from deformation and allows for easy insertion of cables
- Fulfils the requirements of IEC CISPR25 for radio disturbances in vehicles, boats and engines

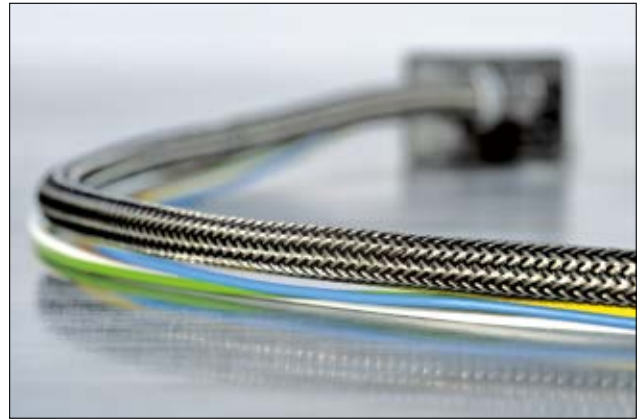

HEGEMIP braided sleeving: reliable protection from electromagnetic radiation.

MATERIAL	Polyester, halogen free (PET), Tin Plated copper (SNCU)
Operating Temperature	-40 °C to +150 °C
EMI requirements	10 KHz to 1 GHz according to CISPR25 (DIN VDE 0879-2)
Flammability	UL 94 V2, FMVSS 302



TYPE	Ø (D)	Bundle Ø min.	Bundle Ø max.	Colour	Weight	Reel Length	Article-No.
HEGEMIP04	4	4	6	Tin coloured and Black	22 g/m	100 m	173-00400
HEGEMIP06	6	5	10	Tin coloured and Black	29 g/m	100 m	173-00600
HEGEMIP08	8	8	11	Tin coloured and Black	36 g/m	100 m	173-00800
HEGEMIP10	10	8	13	Tin coloured and Black	44 g/m	50 m	173-01000
HEGEMIP12	12	10	15	Tin coloured and Black	48 g/m	50 m	173-01200
HEGEMIP14	14	12	18	Tin coloured and Black	58 g/m	100 m	173-01400
HEGEMIP16	16	14	20	Tin coloured and Black	73 g/m	100 m	173-01600
HEGEMIP18	18	16	22	Tin coloured and Black	79 g/m	50 m	173-01800
HEGEMIP20	20	18	25	Tin coloured and Black	100 g/m	50 m	173-02000

All dimensions in mm. Subject to technical changes.
Cuts in any lengths. Minimum Order Quantity (MOQ) may differ from package content.



Add items to your watchlist!

www.HT.click/49-361



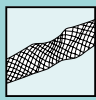

Electromagnetic protection braided sleeving for hybrid automobiles

Helagaine HEGEMIP-HY

Helagaine HEGEMIP-HY provides electromagnetic protection in hybrid automobiles.

Features and benefits

- Excellent electromagnetic protection
- Extremely flexible, expandable and easy to apply
- No kinks or ruptures even when bent at sharp angles
- Superior abrasion protection
- Special copper alloy for enhanced protection against salt spray
- Particularly suitable for applications with restricted space or requiring movement
- Inner disposable tube protects sleeve from deformation and allows for easy insertion of cables
- Fulfils the requirements of IEC CISPR25 for radio disturbances in vehicles, boats and engines



HEGEMIP-HY braided sleeving: EMI protection for hybrid automobiles.

MATERIAL	Polyester (PET), Tin Plated copper (SNCU)
Operating Temperature	-40 °C to +150 °C
EMI requirements	10 kHz to 1 GHz according to CISPR25 (DIN VDE 0879-2)
Flammability	UL 94 V2, FMVSS 302



TYPE	Ø (D)	Bundle Ø min.	Bundle Ø max.	Colour	Weight	Reel Length	Article-No.
HEGEMIP-HY20	20	19	27	Orange (OG)	72 g/m	50 m	173-02001
HEGEMIP-HY30	30	25	35	Orange (OG)	101 g/m	50 m	173-03000
HEGEMIP-HY35	35	30	40	Orange (OG)	120 g/m	50 m	173-03501
HEGEMIP-HY40	40	30	50	Orange (OG)	180 g/m	50 m	173-04000
HEGEMIP-HY50	50	40	60	Orange (OG)	193 g/m	50 m	173-05000

All dimensions in mm. Subject to technical changes.
Cuts in any lengths. Minimum Order Quantity (MOQ) may differ from package content.



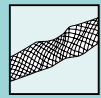

Electromagnetic protection braided sleeving for defence applications

Helagaine HEGEMIP-VG

Helagaine HEGEMIP-VG provides electromagnetic protection for the defence industry.

Features and benefits

- Excellent electromagnetic protection
- Very flexible, expandable and easy to apply
- Especially suitable for applications in tight areas or requiring movement
- Inner disposable tube protects sleeve from deformation and allows for easy insertion of cables
- Very good abrasion resistance
- Approved to military norm VG 96936-10 / Type A



HEGEMIP-VG braided sleeving with VG approval for defence applications.

MATERIAL	Tin Plated copper (SNCU)
Operating Temperature	-65 °C to +150 °C
Flammability	UL 94 V2, FMVSS 302



TYPE	Ø (D)	Bundle Ø min.	Bundle Ø max.	Colour	Weight	Reel Length	Article-No.
HEGEMIP-VG03	3	3.5	5.0	Metal (ML)	19 g/m	500 m	173-00200
HEGEMIP-VG04	4	4.5	7.0	Metal (ML)	30 g/m	500 m	173-00201
HEGEMIP-VG06	6	5.5	8.5	Metal (ML)	37 g/m	500 m	173-00202
HEGEMIP-VG07.5	7.5	7.5	13.5	Metal (ML)	71 g/m	500 m	173-00203
HEGEMIP-VG10	10	13.0	17.5	Metal (ML)	96 g/m	250 m	173-00204
HEGEMIP-VG12.5	12.5	15.0	19.5	Metal (ML)	100 g/m	200 m	173-00205
HEGEMIP-VG20	20	19.0	30.0	Metal (ML)	265 g/m	100 m	173-00206

All dimensions in mm. Subject to technical changes.
Minimum Order Quantity (MOQ) may differ from package content.



For product specific approvals and specifications please refer to the Appendix.



Add items to your watchlist!

www.HT.click/49-363





Rigid PVC wiring ducts

HelaDuct HTWD-PN for small-diameter wires (metric sizes)

HelaDuct HTWD-PN wiring ducts are used to route and protect wires in control panels and switching systems.

Features and benefits

- Narrow slots suitable for small-diameter wires
- Smooth, burr-free edges protect installers from injury and wires from damage
- Fingers can be removed with no sharp edges at pre-notched snap-off points
- Further pre-notched snap-off point at base of sidewall allow cutting out and removing sections of sidewall with no sharp edges
- Raised mounting points for easily and securely fastening wire retainers and other accessories prior to cabling
- Wire retainers and accessories leave no protruding parts below surface of duct
- Duct covers are easy to mount and remove, yet hold securely even in a vertical position and under vibration
- Cover is flush with side of duct, allowing for tight, contiguous placement of ducts
- Additional retainer nub on fingers on ducts height 80 and above to prevent cables from slipping
- Base perforation according to DIN EN 50085

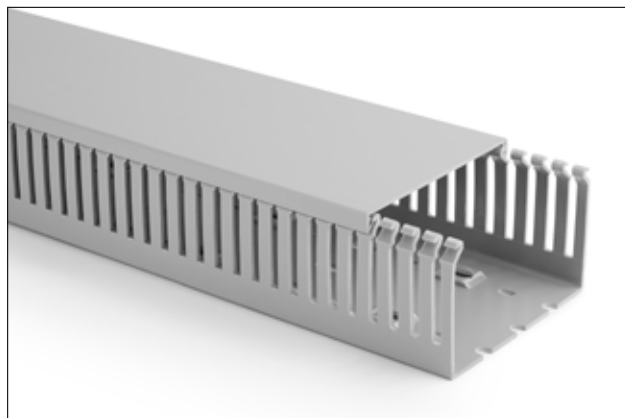

HelaDuct HTWD-PN - narrow finger wiring duct.

MATERIAL	Polyvinylchloride (PVC)
Colour	Grey (GY)
Length (L)	2 m
Operating Temperature	-5 °C to +65 °C
Flammability	UL 94 V0

RoHS

Nominal Dimensions HTWD-PN/ HTWD-PW

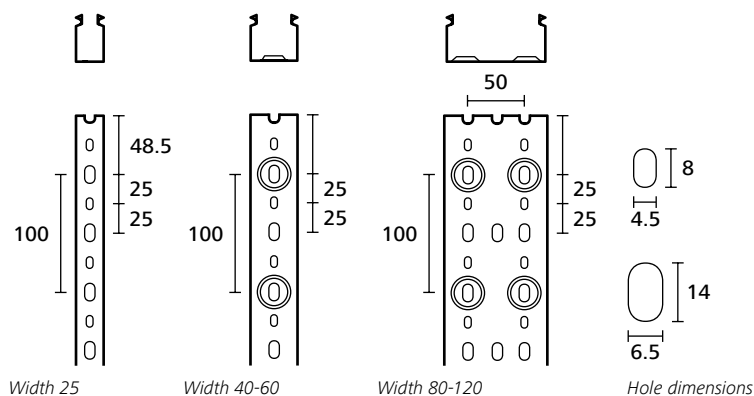

www.HellermannTyton.co.uk/HTWD-PN-cat22



Rigid PVC wiring ducts

HelaDuct HTWD-PN for small-diameter wires (metric sizes)

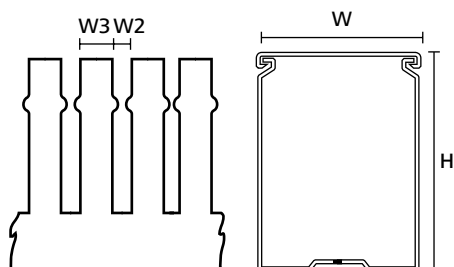

Wiring duct HTWD-PN

TYPE	Width (W)	Height (H)	Width (W2)	Width (W3)	Pack Cont.	Article-No.
HTWD-PN-25X40	25	40	4	6	72 m	184-10068
HTWD-PN-25X60	25	60	4	6	48 m	184-10138
HTWD-PN-25X80	25	80	4	6	48 m	184-10198
HTWD-PN-40X40	40	40	4	6	40 m	184-10078
HTWD-PN-40X60	40	60	4	6	36 m	184-10148
HTWD-PN-40X80	40	80	4	6	32 m	184-10208
HTWD-PN-40X100	40	100	4	6	16 m	184-10258
HTWD-PN-60X40	60	40	4	6	24 m	184-10088
HTWD-PN-60X60	60	60	4	6	24 m	184-10158
HTWD-PN-60X80	60	80	4	6	24 m	184-10218
HTWD-PN-60X100	60	100	4	6	8 m	184-10268
HTWD-PN-80X40	80	40	4	6	24 m	184-10098
HTWD-PN-80X60	80	60	4	6	24 m	184-10168
HTWD-PN-80X80	80	80	4	6	24 m	184-10228
HTWD-PN-80X100	80	100	4	6	8 m	184-10329
HTWD-PN-100X40	100	40	4	6	16 m	184-10108
HTWD-PN-100X60	100	60	4	6	16 m	184-10178
HTWD-PN-100X80	100	80	4	6	16 m	184-10238
HTWD-PN-100X100	100	100	4	6	8 m	184-10278
HTWD-PN-120X60	120	60	4	6	16 m	184-10188
HTWD-PN-120X80	120	80	4	6	16 m	184-10248

All dimensions in mm. Subject to technical changes.
Minimum Order Quantity (MOQ) may differ from package content.



For product specific approvals and specifications please refer to the Appendix.



Add items to your watchlist!

www.HT.click/49-365



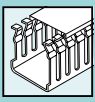

Rigid PVC wiring ducts

HelaDuct HTWD-PW for large-diameter wires (metric sizes)

HelaDuct HTWD-PW wiring ducts are used to route and protect wires in control panels and switching systems.

Features and benefits

- Wide slots suitable for large-diameter wires
- Wide fingers provide additional wire support
- Smooth, burr-free edges protect installers from injury and wires from damage
- Fingers can be removed with no sharp edges at pre-notched snap-off points
- Further pre-notched snap-off point at base of sidewall allow cutting out and removing sections of sidewall with no sharp edges
- Raised mounting points for easily, quickly and securely fastening wire retainers and other accessories prior to cabling
- Wire retainers and accessories leave no protruding parts below surface of duct
- Duct covers are easy to mount and remove, yet hold securely even in a vertical position and under vibration
- Cover is flush with side of duct, allowing for tight, contiguous placement of ducts
- Additional retainer nub on fingers on ducts height 80 and above to prevent cables from slipping
- Base perforation according to DIN EN 50085

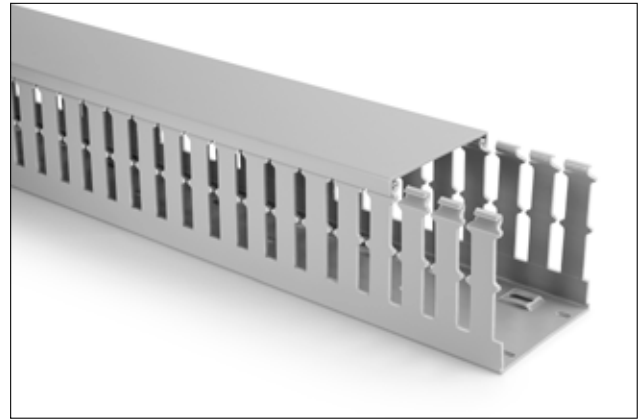

HelaDuct HTWD-PW - wide finger wiring duct.

MATERIAL	Polyvinylchloride (PVC)
Colour	Grey (GY)
Length (L)	2 m
Operating Temperature	-5 °C to +65 °C
Flammability	UL 94 V0



www.HellermannTyton.co.uk/HTWD-PW-cat22

Nominal Dimensions HTWD-PN/ HTWD-PW

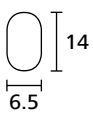
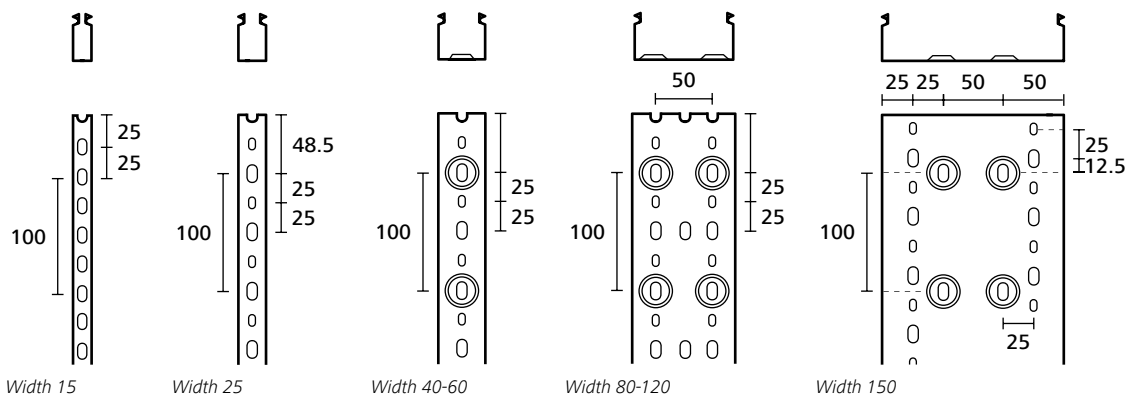

Hole dimensions



For product specific approvals and specifications please refer to the Appendix.



Rigid PVC wiring ducts

HelaDuct HTWD-PW for large-diameter wires (metric sizes)

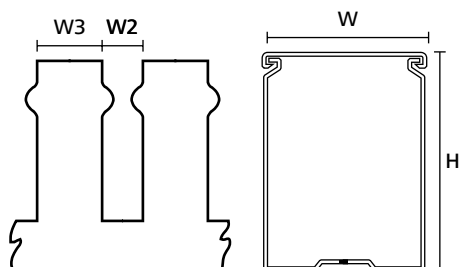

Wiring duct HTWD-PW/ HTWD-PWB

TYPE	Width (W)	Height (H)	Width (W2)	Width (W3)	Pack Cont.	Article-No.
HTWD-PW-15X18	15	18	5	7.5	72 m	181-10018
HTWD-PW-15X30	15	30	5	7.5	64 m	181-10038
HTWD-PW-15X40	15	40	5	7.5	48 m	181-10058
HTWD-PW-15X60	15	60	5	7.5	32 m	181-10118
HTWD-PW-25X30	25	30	5	7.5	72 m	181-10028
HTWD-PW-25X40	25	40	8	12	72 m	181-10068
HTWD-PW-25X60	25	60	8	12	48 m	181-10138
HTWD-PW-25X80	25	80	8	12	48 m	181-10198
HTWD-PW-25X100	25	100	8	12	16 m	181-10328
HTWD-PW-40X40	40	40	8	12	40 m	181-10078
HTWD-PW-40X60	40	60	8	12	36 m	181-10148
HTWD-PW-40X80	40	80	8	12	32 m	181-10208
HTWD-PW-40X100	40	100	8	12	16 m	181-10258
HTWD-PW-60X40	60	40	8	12	24 m	181-10088
HTWD-PW-60X60	60	60	8	12	24 m	181-10158
HTWD-PW-60X80	60	80	8	12	24 m	181-10218
HTWD-PW-60X100	60	100	8	12	8 m	181-10268
HTWD-PW-80X40	80	40	8	12	24 m	181-10098
HTWD-PW-80X60	80	60	8	12	24 m	181-10168
HTWD-PW-80X80	80	80	8	12	24 m	181-10228
HTWD-PW-80X100	80	100	8	12	8 m	181-10329
HTWD-PW-100X40	100	40	8	12	16 m	181-10108
HTWD-PW-100X60	100	60	8	12	16 m	181-10178
HTWD-PW-100X80	100	80	8	12	16 m	181-10238
HTWD-PW-100X100	100	100	8	12	8 m	181-10278
HTWD-PW-120X60	120	60	8	12	16 m	181-10188
HTWD-PW-120X80	120	80	8	12	16 m	181-10248
HTWD-PW-150X100	150	100	8	12	8 m	181-10288

All dimensions in mm. Subject to technical changes.
Minimum Order Quantity (MOQ) may differ from package content.



For product specific approvals and specifications please refer to the Appendix.



Add items to your watchlist!

www.HT.click/49-367





Rigid PVC wiring ducts

HelaDuct HTWD-PD (DIN-sizes)

HelaDuct HTWD-PD wiring ducts are used to route and protect wires in control panels and switching systems.

Features and benefits

- Narrow slots suitable for small-diameter wires
- Smooth, burr-free edges protect installers from injury and wires from damage
- Fingers can be removed with no sharp edges at pre-notched snap-off points
- Further pre-notched snap-off point at base of sidewall allow cutting out and removing sections of sidewall with no sharp edges
- Duct covers are easy to mount and remove, yet hold securely even in a vertical position and under vibration
- Cover is flush with side of duct, allowing for tight, contiguous placement of ducts
- Base perforation according to DIN EN 50085



HelaDuct HTWD-PD - DIN sized wiring duct.

MATERIAL	Polyvinylchloride (PVC)
Colour	Grey (GY)
Length (L)	2 m
Operating Temperature	-5 °C to +60 °C
Flammability	UL 94 V0

RoHS

Nominal Dimensions HTWD-PD DIN

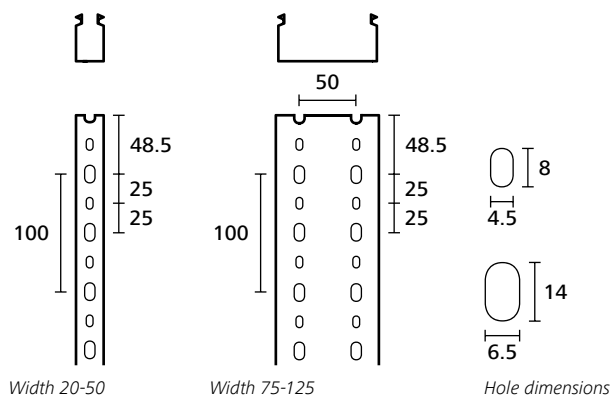



Rigid PVC wiring ducts

HelaDuct HTWD-PD (DIN-sizes)

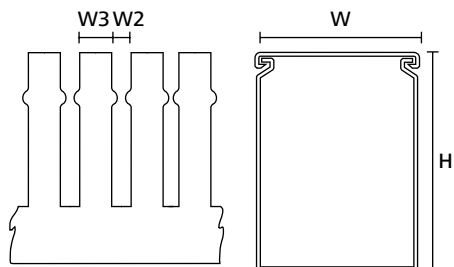

Wiring duct HTWD-PD

TYPE	Width (W)	Height (H)	Width (W2)	Width (W3)	Pack Cont.	Article-No.
HTWD-PD-20X20	20	20	4	6	64 m	185-42020
HTWD-PD-20X37.5	20	37.5	4	6	32 m	185-42037
HTWD-PD-20X50	20	50	4	6	20 m	185-42050
HTWD-PD-25X25	25	25	5	7.5	48 m	185-42525
HTWD-PD-25X50	25	50	5	7.5	18 m	185-42550
HTWD-PD-25X75	25	75	5	7.5	32 m	185-42575
HTWD-PD-37.5X25	37.5	25	5	7.5	64 m	185-43725
HTWD-PD-37.5X37.5	37.5	37.5	5	7.5	32 m	185-43737
HTWD-PD-37.5X50	37.5	50	5	7.5	40 m	185-43750
HTWD-PD-37.5X75	37.5	75	5	7.5	40 m	185-43775
HTWD-PD-50X50	50	50	5	7.5	48 m	185-45050
HTWD-PD-50X75	50	75	5	7.5	20 m	185-45075
HTWD-PD-50X100	50	100	5	7.5	24 m	185-45010
HTWD-PD-75X50	75	50	5	7.5	20 m	185-47550
HTWD-PD-75X75	75	75	5	7.5	16 m	185-47575
HTWD-PD-75X100	75	100	5	7.5	16 m	185-47510
HTWD-PD-100X50	100	50	5	7.5	24 m	185-41050
HTWD-PD-100X75	100	75	5	7.5	16 m	185-41075
HTWD-PD-100X100	100	100	5	7.5	8 m	185-41010
HTWD-PD-125X50	125	50	5	7.5	18 m	185-41250
HTWD-PD-125X75	125	75	5	7.5	12 m	185-41275

All dimensions in mm. Subject to technical changes.
Minimum Order Quantity (MOQ) may differ from package content.



For product specific approvals and specifications please refer to the Appendix.



Add items to your watchlist!

www.HT.click/49-369





Halogen-free wiring ducts

HelaDuct HTWD-HF (metric sizes)

HelaDuct HTWD-HF wiring ducts are used to route and protect wires in control panels and switching systems where there are high demands on personal or material safety in case of fire, such as in public transport, tunnels, data-processing centers or public buildings.

Features and benefits

- Excellent fire-safety characteristics according to UL94 und EN 45545-2
- Narrow slots suitable for small-diameter wires
- Smooth, burr-free edges protect installers from injury and wires from damage
- Fingers can be removed with no sharp edges at pre-notched snap-off points
- Further pre-notched snap-off point at base of sidewall allow cutting out and removing sections of sidewall with no sharp edges
- Duct covers hold securely even in a vertical position and under vibration
- Cover is flush with side of duct, allowing for tight, contiguous placement of duct
- Base perforation according to DIN EN 50085



HelaDuct HTWD-HF - halogenfree wiring duct.

MATERIAL	Acrylonitrile Butadiene Styrene alloyed with Polycarbonate (PC/ABS)
Colour	Grey (GY)
Length (L)	2.0 m
Operating Temperature	-25 °C to +90 °C
Flammability	UL 94 V0
EN 45545-2 Classification	R22 HL2, R23 HL2

Hole pattern acc. to DIN EN 50085

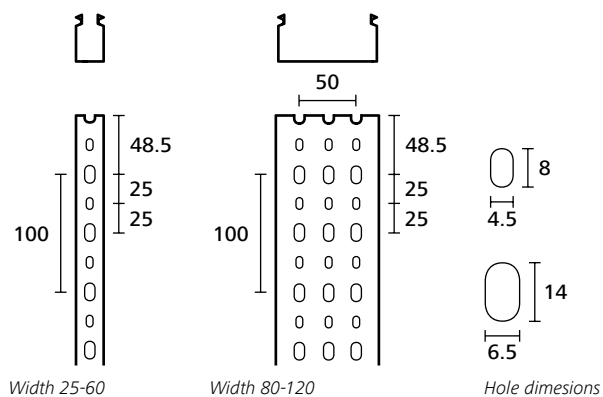

HF ✓

RoHS ✓

EN 45545-2 

For product specific approvals and specifications please refer to the Appendix.



Halogen-free wiring ducts

HelaDuct HTWD-HF (metric sizes)

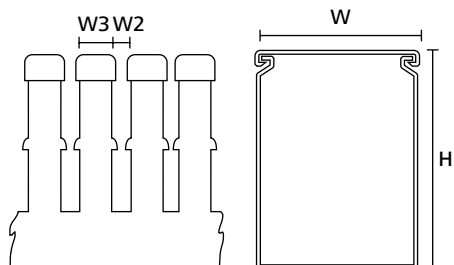

HelaDuct Wiring ducts HTWD-HF

TYPE	Width (W)	Height (H)	Width (W2)	Width (W3)	Pack Cont.	Article-No.
HTWD-HF-25X25	25.0	25.0	6	6.5	50.0 m	183-22525
HTWD-HF-25X40	25.0	40.0	6	6.5	48.0 m	183-22540
HTWD-HF-25X60	25.0	60.0	6	6.5	60.0 m	183-25060
HTWD-HF-25X80	25.0	80.0	6	6.5	20.0 m	183-22580
HTWD-HF-40X25	40.0	25.0	6	6.5	48.0 m	183-24025
HTWD-HF-40X40	40.0	40.0	6	6.5	50.0 m	183-24040
HTWD-HF-40X60	40.0	60.0	6	6.5	40.0 m	183-24060
HTWD-HF-40X80	40.0	80.0	6	6.5	20.0 m	183-24080
HTWD-HF-60X40	60.0	40.0	6	6.5	40.0 m	183-26040
HTWD-HF-60X60	60.0	60.0	6	6.5	24.0 m	183-26060
HTWD-HF-60X80	60.0	80.0	6	6.5	20.0 m	183-26080
HTWD-HF-60X100	60.0	100.0	6	6.5	12.0 m	183-26010
HTWD-HF-80X40	80.0	40.0	6	6.5	20.0 m	183-28040
HTWD-HF-80X60	80.0	60.0	6	6.5	20.0 m	183-28060
HTWD-HF-80X80	80.0	80.0	6	6.5	12.0 m	183-28080
HTWD-HF-80X100	80.0	100.0	6	6.5	10.0 m	183-28010
HTWD-HF-100X40	100.0	40.0	6	6.5	20.0 m	183-22040
HTWD-HF-100X60	100.0	60.0	6	6.5	16.0 m	183-21060
HTWD-HF-100X80	100.0	80.0	6	6.5	12.0 m	183-21080
HTWD-HF-100X100	100.0	100.0	6	6.5	8.0 m	183-21010
HTWD-HF-120X60	120.0	60.0	6	6.5	12.0 m	183-21260
HTWD-HF-120X80	120.0	80.0	6	6.5	16.0 m	183-21280

All dimensions in mm. Subject to technical changes.
Minimum Order Quantity (MOQ) may differ from package content.

EN 45545-2



For product specific approvals and specifications please refer to the Appendix.



Add items to your watchlist!

www.HT.click/49-371



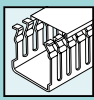

Flexible cable support

HelaDuct flexible cable supports are commonly used in switching cabinets. They are also used in the furniture industry, where cables need to be routed rapidly and attractively.

Features and benefits

- Space-saving wiring system
- Highly flexible, can be installed at angles of 90° and higher
- Cable clearly open to view
- Rapid mounting with screws or adhesive strip with high-quality foam bonding layer

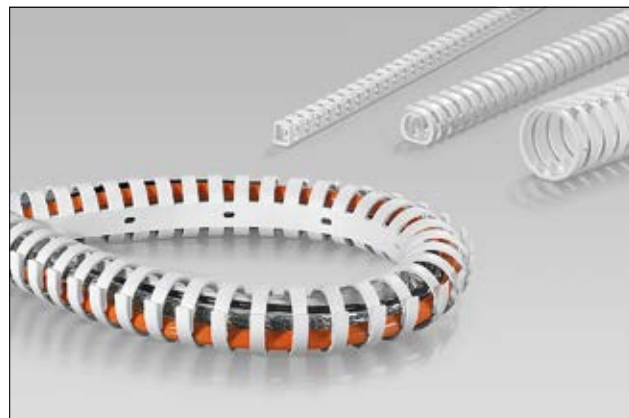

HelaDuct Flex can be installed at angles above 90°.

MATERIAL	Polypropylene (PP)
Operating Temperature	-20 °C to +70 °C, (+80 °C, 200 h)
Adhesive	Synthetic rubber with base of polyethylene foam
Flammability	UL 94 V0 (excluding adhesive)



HelaDuct Flex Screw Mounting

TYPE	Nominal Ø	Fixation Method	No. of Wires		Colour	Length (L)	Pack Cont.	Article-No.
			6 x 1.50 mm ²	4 x 2.50 mm ²				
HelaDuct Flex10	10	Screw Mounting	6 x 1.50 mm ²	4 x 2.50 mm ²	White (WH)	500	100 pcs.	164-11008
HelaDuct Flex20	20	Screw Mounting	22 x 1.50 mm ²	14 x 2.50 mm ²	White (WH)	500	70 pcs.	164-21008
HelaDuct Flex30	30	Screw Mounting	50 x 1.50 mm ²	34 x 2.50 mm ²	White (WH)	500	40 pcs.	164-31008
HelaDuct Flex40	40	Screw Mounting	81 x 2.50 mm ²	60 x 2.50 mm ²	White (WH)	500	24 pcs.	164-41008

All dimensions in mm. Subject to technical changes.
Minimum Order Quantity (MOQ) may differ from package content.

HelaDuct Flex Screw Mounting with Adhesive

TYPE	Nominal Ø	Fixation Method	No. of Wires		Colour	Length (L)	Pack Cont.	Article-No.
			6 x 1.50 mm ²	4 x 2.50 mm ²				
HelaDuct Flex10SK	10	Screw Mounting and Adhesive	6 x 1.50 mm ²	4 x 2.50 mm ²	White (WH)	500	100 pcs.	164-11108
HelaDuct Flex20SK	20	Screw Mounting and Adhesive	22 x 1.50 mm ²	14 x 2.50 mm ²	White (WH)	500	70 pcs.	164-21108
HelaDuct Flex30SK	30	Screw Mounting and Adhesive	50 x 1.50 mm ²	34 x 2.50 mm ²	White (WH)	500	40 pcs.	164-31108
HelaDuct Flex40SK	40	Screw Mounting and Adhesive	81 x 2.50 mm ²	60 x 2.50 mm ²	White (WH)	500	24 pcs.	164-41108

All dimensions in mm. Subject to technical changes.
Minimum Order Quantity (MOQ) may differ from package content.



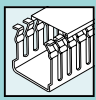

For mounting prior to wiring

HelaDuct HTWD-BWR Base Wire Retainers

HelaDuct Base Wire Retainers HTWD-BWR are anchored securely on the raised mounting points of HTWD-PN and HTWD-PW ducts to allow insertion of wires. Wires are held in place during wiring, for instance in a vertical position or during ceiling installation.

Features and benefits

- Quickly and easily fastened on raised mounting points with a 1/4 turn of a screwdriver
- Wires easily inserted and firmly held in place
- Anchor of retainer remains inside raised mounting point and does not protrude below surface of duct base
- Reduces strain on duct fingers especially at corners and eliminates bulging against sidewall
- Available for all duct sizes of width and height larger than 40
- Fits snugly in duct for minimal loss of installation space

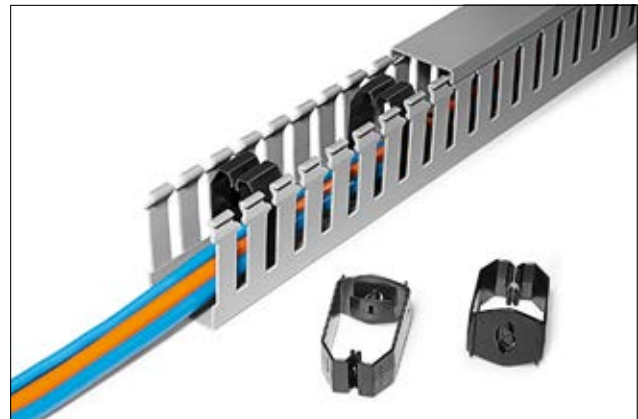

HTWD-BWR wire retainers are easy to mount and hold wires firmly during wiring.

MATERIAL	Acrylonitrile Butadiene Styrene alloyed with Polycarbonate (PC/ABS)
Operating Temperature	-5 °C to +80 °C
Flammability	UL 94 HB

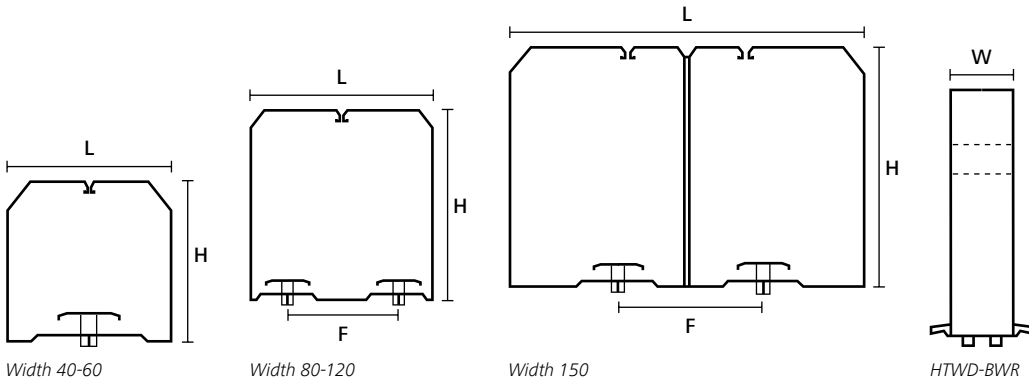

TYPE	Length (L)	Height (H)	Width (W)	Fixing Hole Centres (F)	Colour	Pack Cont.	Article-No.
HTWD-BWR-40X80	34	75	20	-	Black (BK)	20 pcs.	181-50480
HTWD-BWR-40X40	35	36	20	-	Black (BK)	40 pcs.	181-50440
HTWD-BWR-40X60	35	56	20	-	Black (BK)	40 pcs.	181-50460
HTWD-BWR-60X60	54	55	20	-	Black (BK)	20 pcs.	181-50660
HTWD-BWR-60X80	54	75	20	-	Black (BK)	20 pcs.	181-50680
HTWD-BWR-60X100	54	95	20	-	Black (BK)	20 pcs.	181-50690
HTWD-BWR-60X40	55	35	20	-	Black (BK)	40 pcs.	181-50640
HTWD-BWR-80X60	74	55	20	50	Black (BK)	10 pcs.	181-50860
HTWD-BWR-80X80	74	74	20	50	Black (BK)	10 pcs.	181-50880
HTWD-BWR-80X100	74	94	20	50	Black (BK)	30 pcs.	181-50890
HTWD-BWR-100X100	93	94	20	50	Black (BK)	5 pcs.	181-51090
HTWD-BWR-100X60	94	55	20	50	Black (BK)	10 pcs.	181-51060
HTWD-BWR-100X80	94	75	20	50	Black (BK)	10 pcs.	181-51080
HTWD-BWR-120X80	113	74	20	50	Black (BK)	10 pcs.	181-51280
HTWD-BWR-120X60	114	54	20	50	Black (BK)	10 pcs.	181-51260
HTWD-BWR-150X100	143	94	20	50	Black (BK)	5 pcs.	181-51590

All dimensions in mm. Subject to technical changes.
Minimum Order Quantity (MOQ) may differ from package content.



Add items to your watchlist!

www.HT.click/49-373



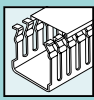

For mounting to duct fingers

HelaDuct HTWD-NFWR and HTWD-WFWR Wire Retainers

The Narrow Finger and Wide Finger Wire Retainers HTWD-NFWR and HTWD-WFWR are easily attached to HelaDuct wiring duct fingers to hold wires securely in place during installation and when the cover is removed.

Features and benefits

- Prevents wires from falling out even when vertical routed
- Easily inserted onto single fingers of duct
- Height can be freely adjusted
- Does not block insertion of wirings into slots
- One retainer for all duct widths: length of retainer can be shortened at break-off points to duct width
- HTWD-NFWR is compatible with HelaDuct HTWD-PN and HTWD-HF (metric sizes)
- HTWD-WFWR is compatible with HelaDuct HTWD-PW ducts

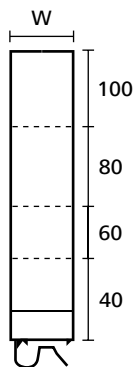

HTWD-NFWR, -WFWR

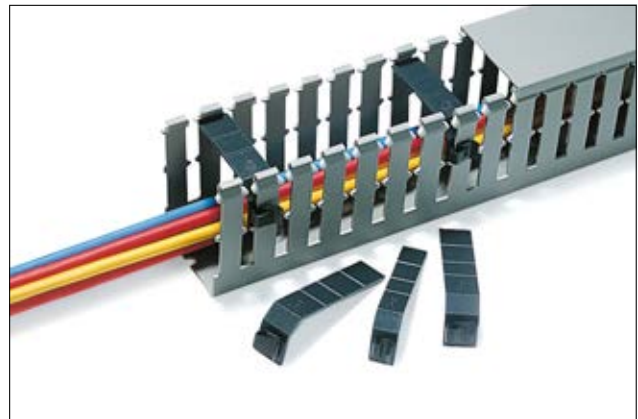

HTWD-NFWR and HTWD-WFWR hold wires in place even when cover is removed.

MATERIAL	Acrylonitrile Butadiene Styrene (ABS)
Operating Temperature	-40 °C to +80 °C
Flammability	UL 94 HB

HF ✓

RoHS ✓

TYPE	For Wiring Ducts	Width (W)	Colour	Pack Cont.	Article-No.
HTWD-NFWR	HTWD-PN, HTWD-HF	14	Black (BK)	100 pcs.	181-10020
HTWD-WFWR	HTWD-PW	18	Black (BK)	100 pcs.	181-10010

All dimensions in mm. Subject to technical changes.
Minimum Order Quantity (MOQ) may differ from package content.





For fixing cable ties to base of ducts

HelaDuct HTWD-CTH cable tie holder

HelaDuct HTWD-CTH is used to anchor a cable tie securely to the base of a duct.

Features and benefits

- Holds all components firmly in place
- Cable tie easily laced through HTWD-CTH
- Anchor of mount remains inside raised mounting point and does not protrude below surface of duct base

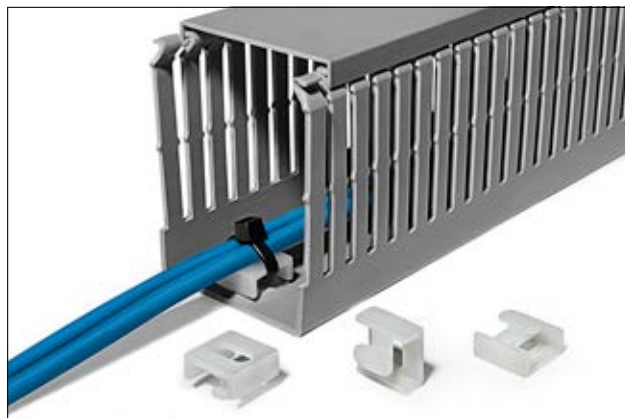

HTWD-CTH for fixing cable ties to base of ducts.

MATERIAL	Polyamide 6 (PA6)
Operating Temperature	-40 °C to +80 °C
Flammability	UL 94 V2

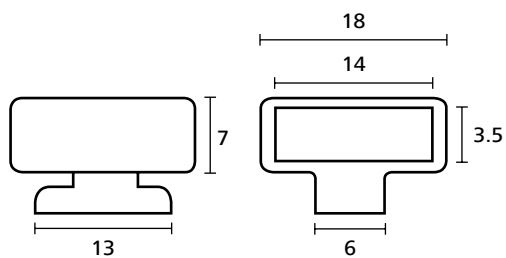

HTWD-CTH Mount

HTWD-CTH Mount

TYPE	For Wiring Ducts	Colour	Pack Cont.	Article-No.
HTWD-CTH	HTWD-PN, HTWD-PW	White (WH)	50 pcs.	181-45029

Subject to technical changes.
Minimum Order Quantity (MOQ) may differ from package content.



Add items to your watchlist!
www.HT.click/49-375



For installing wiring ducts into fixing holes

HelaDuct HTWD-R4 and HTWD-R6 rivets

HTWD-R4 and HTWD-R6 are used to rapidly mount and secure wiring ducts into fixing holes without the use of screws.

Features and benefits

- Very good mechanical properties
- Good resistance to vibration
- Easily and rapidly applied with HTWD-RT4 and HTWD-RT6 rivet tools
- Colour-coded for easy identification for use with rivet tools

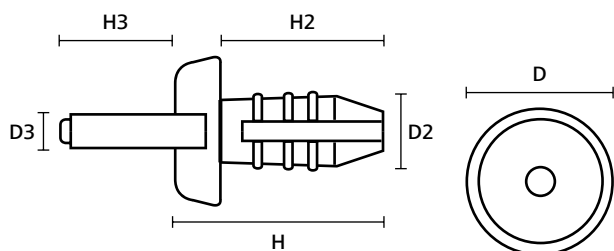

HTWD-R4, -R6



HTWD-R4 and HTWD-R6 Rivet.

MATERIAL	Polyamide 6 (PA6)
Operating Temperature	-40 °C to +80 °C
Flammability	UL 94 V2

HF ✓

RoHS ✓

TYPE	Height (H)	Height (H2)	Height (H3)	Ø (D)	Ø (D2)	Ø (D3)	Colour	Pack Cont.	Article-No.
HTWD-R4	14.0	12.0	11.5	9.0	5.0	2.0	Blue (BU)	1,000 pcs.	181-42400
HTWD-R6	16.0	12.7	13.0	11.0	6.0	3.0	Black (BK)	250 pcs.	181-42600
	16.0	14.0	13.5	11.0	7.5	4.0	Orange (OG)	500 pcs.	181-42500

All dimensions in mm. Subject to technical changes.
Minimum Order Quantity (MOQ) may differ from package content.

For inserting R4 and R6 rivets

HelaDuct HTWD-RT4 and HTWD-RT6 Rivet Tools

HelaDuct HTWD-RT4 and HTWD-RT6 tools are used to insert HTWD-R4 and HTWD-R6 rivets into fixing holes and thus mounting ducts without the use of screws.

Features and benefits

- Durable and reliable
- Long aluminum body enables insertion even into very high ducts
- Soft plastic ergonomic handle
- Colour-coded for easy identification for use with correct rivets



Rivet Tools HTWD-RT4, -RT6.

MATERIAL	Metal (MET), Plastic (PL)
-----------------	---------------------------

RoHS ✓

TYPE	For Wiring Duct Rivets	Colour	Article-No.
HTWD-RT4	R4	Blue (BU)	181-41542
HTWD-RT6	R6	Orange (OG)	181-41564

Subject to technical changes.





Edge protection for cut-out sections

Flexiform G51P PE grommet strip

Flexiform edge protection is used to protect cables and wires routed through sharp-edged cut-out sections.

Features and benefits

- Very flexible
- Easily and securely applied without adhesives
- Provides effective, orderly-looking protection
- Flexiform G51P made of polyethylene offers general purpose edge protection
- Flexiform G51N made of PA6 offers very good abrasion resistance
- Flexiform G51T made of PTFE offers excellent resistance to high temperatures and most chemicals



Optimal protection of cables and wires at panel edges.

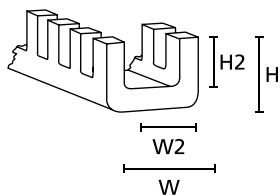

Flexiform edge protection

MATERIAL	Polyethylene (PE)
Operating Temperature	-30 °C to +80 °C
Flammability	UL 94 HB



TYPE	Panel Thickness	Width (W)	Width (W2)	Height (H)	Height (H2)	Material	Colour	Pack Cont.	Article-No.
G51PAA	0.4 - 0.9	2.3	0.9	2.7	1.8	PE	Natural (NA)	25 m	251-10009
G51PA	0.4 - 1.3	3.9	1.5	4.3	2.7	PE	Natural (NA)	25 m	251-10109
G51PB	1.3 - 2.1	4.6	2.4	4.3	2.7	PE	Natural (NA)	25 m	251-10209
G51PC	2.1 - 3.3	5.7	3.5	4.3	2.7	PE	Natural (NA)	25 m	251-10309
G51PD	3.3 - 4.8	8.4	5.1	6.2	4.3	PE	Natural (NA)	25 m	251-10409
G51PE	4.8 - 6.5	9.9	6.7	6.4	4.5	PE	Natural (NA)	25 m	251-10509
G51PF	6.5 - 8.1	11.4	8.3	6.8	4.8	PE	Natural (NA)	25 m	251-10609
G51PG	8.1 - 9.7	13.2	10.1	6.8	4.8	PE	Natural (NA)	25 m	251-10709
G51PH	9.7 - 12.9	16.4	13.2	6.8	4.8	PE	Natural (NA)	25 m	251-10809

All dimensions in mm. Subject to technical changes. Minimum Order Quantity (MOQ) may differ from package content. Flexiform grommet strips are not self-adhesive and therefore not suitable for outer edges.



Add items to your watchlist!

www.HT.click/49-377





Edge protection for cut-out sections

Flexiform G51T PTFE grommet strip

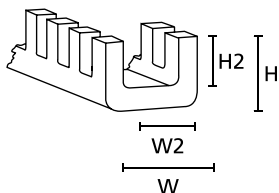

Flexiform edge protection

MATERIAL	Polytetrafluoroethylene (PTFE)
Operating Temperature	-60 °C to +260 °C, intermittent +350 °C
Flammability	UL 94 V0

RoHS ✓

TYPE	Panel Thickness	Width (W)	Width (W2)	Height (H)	Height (H2)	Material	Colour	Pack Cont.	Article-No.
G51TA	0.4 - 1.3	3.9	1.5	4.3	2.7	PTFE	Natural (NA)	3 m	251-30109
G51TB	1.3 - 2.1	4.6	2.4	4.3	2.7	PTFE	Natural (NA)	3 m	251-30209
G51TC	2.1 - 3.3	5.7	3.5	4.3	2.7	PTFE	Natural (NA)	3 m	251-30309
G51TD	3.3 - 4.8	8.4	5.1	6.2	4.3	PTFE	Natural (NA)	3 m	251-30409
G51TE	4.8 - 6.5	9.9	6.7	6.4	4.5	PTFE	Natural (NA)	3 m	251-30509
G51TF	6.5 - 8.1	11.4	8.3	6.8	4.8	PTFE	Natural (NA)	3 m	251-30609
G51TG	8.1 - 9.7	13.2	10.1	6.8	4.8	PTFE	Natural (NA)	3 m	251-30709
G51TH	9.7 - 12.9	16.4	13.2	6.8	4.8	PTFE	Natural (NA)	3 m	251-30809

All dimensions in mm. Subject to technical changes. Minimum Order Quantity (MOQ) may differ from package content.
Flexiform grommet strips are not self-adhesive and therefore not suitable for outer edges.

Edge protection for cut-out sections

Flexiform G51N PA6 grommet strip

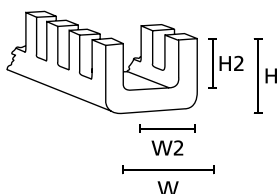

Flexiform edge protection

MATERIAL	Polyamide 6 (PA6)
Operating Temperature	-60 °C to +95 °C
Flammability	UL 94 HB

HF ✓

RoHS ✓

TYPE	Panel Thickness	Width (W)	Width (W2)	Height (H)	Height (H2)	Material	Colour	Pack Cont.	Article-No.
G51NA	0.4 - 1.3	3.9	1.5	4.3	2.7	PA6	Natural (NA)	25 m	251-21109
G51NB	1.3 - 2.1	4.6	2.4	4.3	2.7	PA6	Natural (NA)	25 m	251-21209
G51NC	2.1 - 3.3	5.7	3.5	4.3	2.7	PA6	Natural (NA)	25 m	251-21309
G51ND	3.3 - 4.8	8.4	5.1	6.2	4.3	PA6	Natural (NA)	25 m	251-21409
G51NE	4.8 - 6.5	9.9	6.7	6.4	4.5	PA6	Natural (NA)	25 m	251-21509
G51NF	6.5 - 8.1	11.4	8.3	6.8	4.8	PA6	Natural (NA)	25 m	251-21609
G51NG	8.1 - 9.7	13.2	10.1	6.8	4.8	PA6	Natural (NA)	25 m	251-21709
G51NH	9.7 - 12.9	16.4	13.2	6.8	4.8	PA6	Natural (NA)	25 m	251-21809

All dimensions in mm. Subject to technical changes. Minimum Order Quantity (MOQ) may differ from package content.
Flexiform grommet strips are not self-adhesive and therefore not suitable for outer edges.

NASM

For product specific approvals and specifications please refer to the Appendix.





Beading Edge Protection

EdgeGuard

PVC Beading strip is used to protect cables routed through sharp-edged cutout sections. It can also be used to provide an attractive finish to panel edges.

Features and benefits

- Very flexible
- Easy to apply
- Protects cables from chafing on bulkheads



EdgeGuard protects against sharp panel edges.

MATERIAL	Polyvinylchloride (PVC)
Operating Temperature	-65 °C to +105 °C, intermittent +135 °C
Flammability	UL 94 HB

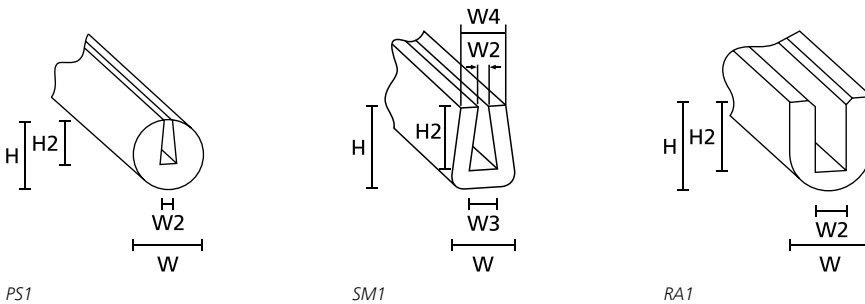

TYPE	Width (W)	Width (W2)	Width (W3)	Width (W4)	Height (H)	Height (H2)	Colour	Pack Cont.	Article-No.
PS1	1.2	0.6	-	-	5.0	3.2	Black (BK)	75 m	800-00200
SM1	5.0	1.0	1.8	4.2	6.3	4.9	Black (BK)	75 m	800-00004
RA1	6.4	2.4	-	-	7.1	5.6	Black (BK)	75 m	800-00001

All dimensions in mm. Subject to technical changes. Minimum Order Quantity (MOQ) may differ from package content.



Add items to your watchlist!

www.HT.click/49-379





Push-on Caps

Push-on caps

The protective push-on caps and elbow grommets are specially constructed to insulate and protect flat pin bushings. The caps and grommets are used in all areas of automotive electronics and in electrical connection systems.

Features and benefits

- Protects effectively against spraying water
- Flexible and easy to apply
- High resistance to chemicals and environmental influences



Push-on caps and elbow grommets in various dimensions.

MATERIAL	Polyvinylchloride (PVC)	Polyvinylchloride, flame retardant (PVC-FR)	Polyethylene (PE)
Operating Temperature	-30 °C to +60 °C		-10 °C to +70 °C
Shore Hardness A	70±5	55±5	Nom. 45
Flammability	UL 94 HB	UL 94 V0	UL 94 HB

RoHS ✓

RoHS ✓

HF ✓

RoHS ✓

TYPE	Drawing	Material	Colour	Pack Cont.	Article-No.
HV4819		PVC-FR	Black (BK)	2,000 pcs.	631-08190
		PVC-FR	Natural (NA)	2,000 pcs.	631-08199
HV4820		PVC	Black (BK)	2,000 pcs.	631-08200
		PVC	Natural (NA)	2,000 pcs.	631-08209
HV4823		PVC	Natural (NA)	2,000 pcs.	631-08239
HV4825		PVC	Natural (NA)	2,000 pcs.	631-08259
OP4827		PE	Natural (NA)	2,000 pcs.	631-58279
OP4828		PE	Natural (NA)	2,000 pcs.	631-58289

Subject to technical changes.





Push-on Caps

Push-on caps

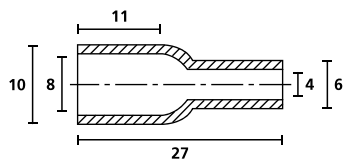

HV4819

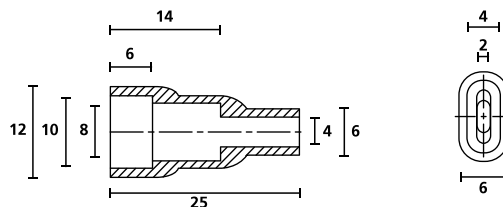

HV4820

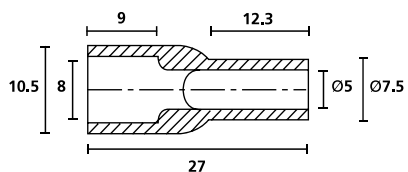

HV4823

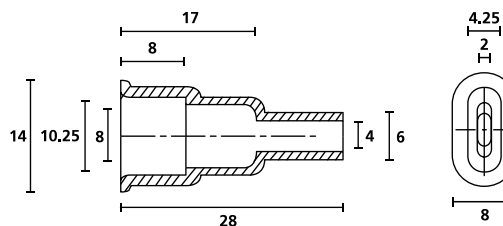

HV4825

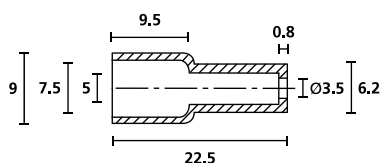

OP4827

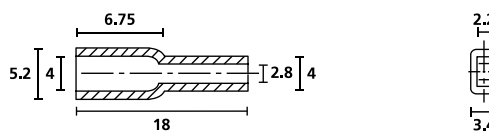

OP4828

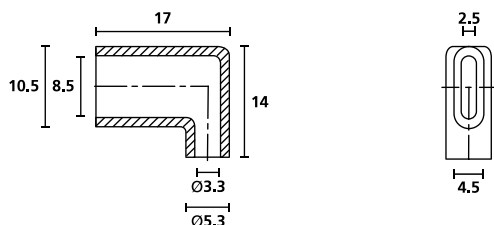

HV4821

TYPE	Drawing	Material	Colour	Pack Cont.	Article-No.
HV4821		PVC-FR	Black (BK)	2,000 pcs.	631-08210
		PVC-FR	Natural (NA)	2,000 pcs.	631-08219

Subject to technical changes.



Add items to your watchlist!

www.HT.click/49-381



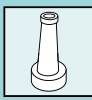

For bend protection at cable exits

Bend protection grommets

Bend protection grommets are typically used for protection of cables at apertures in casings.

Features and benefits

- Routes cables free of kinks and breakage
- Provides strain relief
- Flexible and easy to apply
- High resistance to chemicals und environmental influences



Protection of cables and routing free of kinks and breakage.

MATERIAL	Polyvinylchloride, flame retardant (PVC-FR)
Operating Temperature	-30 °C to +60 °C
Shore Hardness A	55±5
Flammability	UL 94 V0

RoHS

TYPE	Drawing	Colour	Pack Cont.	Article-No.
HV2101		Black (BK)	1,000 pcs.	632-01010
		Grey (GY)	1,000 pcs.	632-01017
		White (WH)	1,000 pcs.	632-01019
HV2101A		Black (BK)	1,000 pcs.	632-01020
HV2103		Black (BK)	1,000 pcs.	632-01030
HV2104		Black (BK)	1,000 pcs.	632-01040
HV2107		Black (BK)	200 pcs.	632-01070
HV2206		Black (BK)	500 pcs.	632-02060
HV2209		Black (BK)	1,000 pcs.	632-02090
HV2210		Black (BK)	1,000 pcs.	632-02100
HV2213		Black (BK)	2,000 pcs.	632-02130
HV2228		Black (BK)	500 pcs.	632-02280

Subject to technical changes.



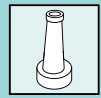

For bend protection at cable exits

Bend protection grommets

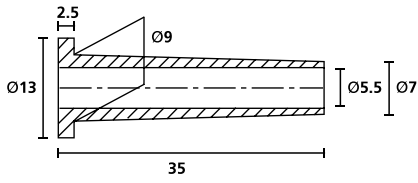

HV2101

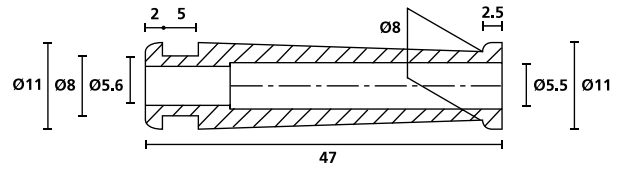

HV2206

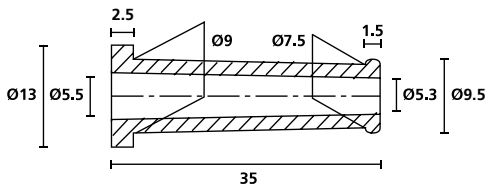

HV2101A

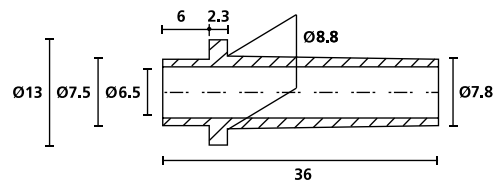

HV2209

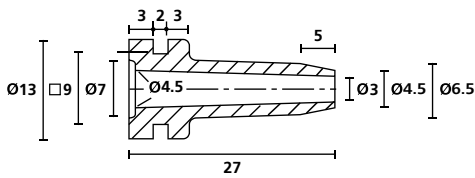

HV2103

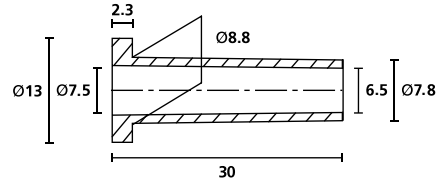

HV2210

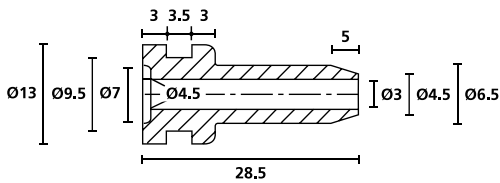

HV2104

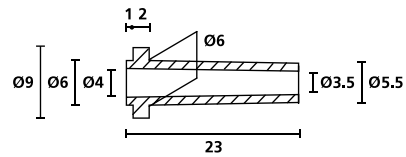

HV2213

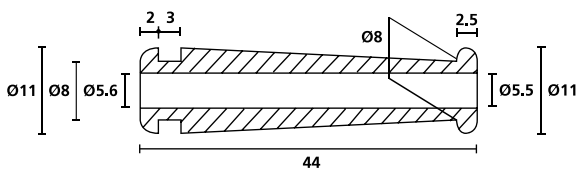

HV2228

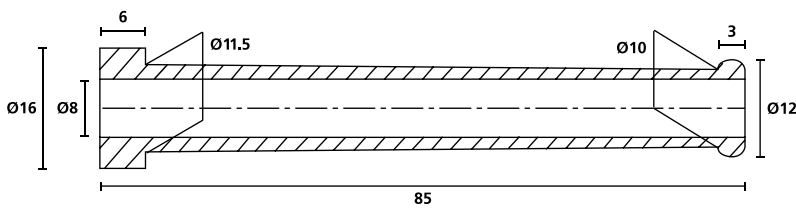

HV2107



For strain relief

Strain relief grommets

Strain protection grommets are used as protection for cables and wires from pulling. They are also used for bend protection in casing apertures. They are especially useful in electrical equipment, for instance in electrical drills.

The use of Hellerine is recommended when working with grommets.

Features and benefits

- Provides excellent strain relieve
- Flexible and easy to apply
- High resistance to chemicals and environmental influences



Bend and strain protection on casings.

MATERIAL	Polyvinylchloride, flame retardant (PVC-FR)	Flexible Polyvinyl Chloride, cadmium free (PVC)
Operating Temperature	-30 °C to +60 °C	
Shore Hardness A	55±5	63±5
Flammability	UL 94 V0	UL 94 HB

RoHS ✓

RoHS ✓

TYPE	Drawing	Outside Ø (OD)	Outside Ø (OD2)	Outside Ø (OD3)	Ø (D)	Ø (D2)	Material	Colour	Pack Cont.	Article-No.
H125		9.0	6.0	-	4.0	3.5	PVC	Black (BK)	1,000 pcs.	634-31250
H126		9.0	6.0	-	5.0	4.5	PVC	Black (BK)	1,000 pcs.	634-31260
		9.0	6.0	-	5.0	4.5	PVC	Grey (GY)	1,000 pcs.	634-31268
H321		8.5	7.0	8.5	6.0	5.5	PVC-FR	Black (BK)	200 pcs.	634-03210
H120		8.0	6.0	8.0	4.5	3.0	PVC-FR	Black (BK)	500 pcs.	634-01200
H121		11.0	8.5	-	8.0	7.0	PVC-FR	Black (BK)	500 pcs.	634-01210

All dimensions in mm. Subject to technical changes.





For strain relief

Strain relief grommets

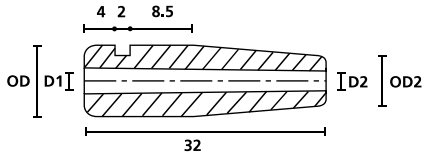

H125/H126

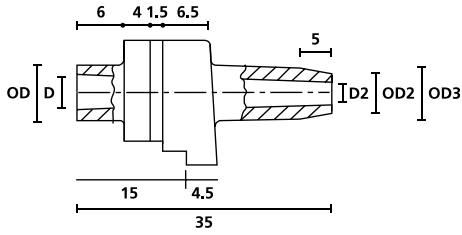
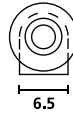

H120

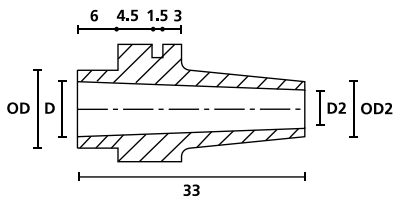
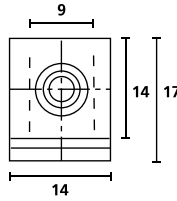

H121

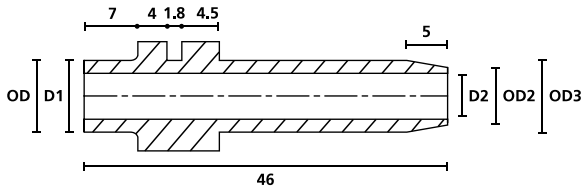
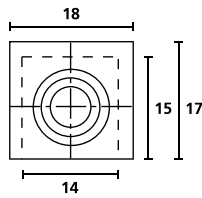

H321

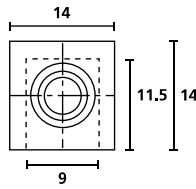



Edge protection grommets

Edge protection grommets

Edge protection grommets are used wherever cable and wires are routed through outlets and apertures. HellermannTyton grommets offer excellent mechanical protection.

Features and benefits

- Protects cables from sharp edges
- Provides additional strain relief
- Flexible and easy to apply
- High resistance to chemicals and environmental influences



Edge protection grommets.

MATERIAL	Polyvinylchloride (PVC)	Polyvinylchloride, flame retardant (PVC-FR)
Operating Temperature	-30 °C to +60 °C	
Shore Hardness A	70±5	55±5
Flammability	UL 94 HB	UL 94 V0

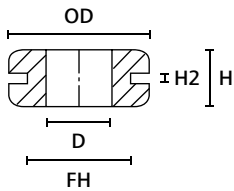

HV1101

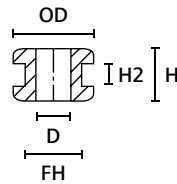

HV1201 to HV1218

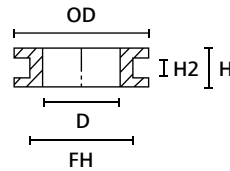

HV1301 to HV1305

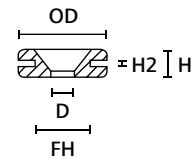

HV1401

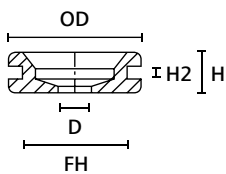

HV1402

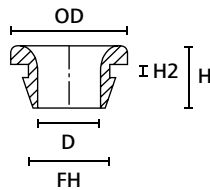

HV1502 to OP1503

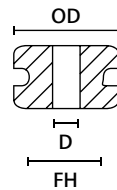

HV1606 to HV1608

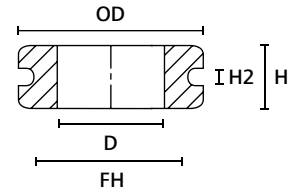

HV1606 to HV1608

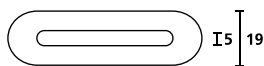

HV1606 to HV1608

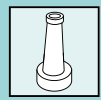

Edge protection grommets

Edge protection grommets

TYPE	Drawing	Outside Ø (OD)	Hole Ø (FH)	Ø (D)	Height (H)	Height (H2)	Material	Colour	Pack Cont.	Article-No.
HV1101		25.5	19.0	12.0	10.0	1.6	PVC-FR	Black (BK)	500 pcs.	633-01010
HV1212		9.0	6.0	4.0	7.0	1.0	PVC-FR	Black (BK)	2,000 pcs.	633-02120
HV1201		9.5	6.4	4.0	5.6	1.6	PVC-FR	Black (BK)	2,000 pcs.	633-02010
HV1201B		9.5	6.4	4.0	6.5	2.5	PVC-FR	Black (BK)	2,000 pcs.	633-02020
HV1215		10.0	8.0	6.0	5.0	1.0	PVC-FR	Black (BK)	2,000 pcs.	633-02150
HV1209		11.0	9.0	4.0	5.5	1.5	PVC-FR	Black (BK)	1,000 pcs.	633-02090
HV1208		14.0	9.5	8.0	8.0	1.5	PVC-FR	Black (BK)	1,000 pcs.	633-02080
HV1207		14.0	10.0	6.0	6.4	1.5	PVC-FR	Black (BK)	1,000 pcs.	633-02070
HV1218		14.0	10.0	6.0	9.0	4.0	PVC-FR	Black (BK)	1,000 pcs.	633-02180
HV1216		14.5	8.0	5.0	6.5	1.5	PVC-FR	Black (BK)	2,000 pcs.	633-02160
HV1210		15.0	9.0	6.0	10.5	2.0	PVC-FR	Black (BK)	1,000 pcs.	633-02100
HV1203		17.5	12.0	10.0	6.8	2.0	PVC-FR	Black (BK)	1,000 pcs.	633-02030
HV1204		17.5	12.0	10.0	8.8	4.0	PVC-FR	Black (BK)	1,000 pcs.	633-02040
HV1206		17.5	12.0	10.0	10.8	6.0	PVC-FR	Black (BK)	1,000 pcs.	633-02060
HV1205		17.5	13.5	10.0	8.7	4.0	PVC-FR	Black (BK)	1,000 pcs.	633-02050
HV1303			15.9	11.0	8.0	6.4	1.6	PVC-FR	Black (BK)	1,000 pcs.
HV1301	15.9		11.0	8.0	7.0	1.0	PVC-FR	Black (BK)	1,000 pcs.	633-03010
HV1302	15.9		11.0	8.0	9.0	3.0	PVC-FR	Black (BK)	1,000 pcs.	633-03020
HV1304	15.9		11.0	8.0	10.8	6.0	PVC-FR	Black (BK)	1,000 pcs.	633-03040
HV1305	24.0		18.0	14.0	7.0	3.0	PVC-FR	Black (BK)	500 pcs.	633-03050
	24.0	18.0	14.0	7.0	3.0	PVC-FR	White (WH)	500 pcs.	633-03059	
HV1401		15.9	9.5	5.0	4.8	0.8	PVC-FR	Black (BK)	1,000 pcs.	633-04010
HV1402		23.0	18.5	6.0	7.0	2.0	PVC-FR	Black (BK)	1,000 pcs.	633-04020
HV1502		11.5	8.0	6.5	8.0	1.5	PVC	Black (BK)	2,000 pcs.	633-05020
HV1606		31.0	25.0	17.0	11.0	3.0	PVC-FR	Grey (GY)	500 pcs.	633-06068
HV1607		43.0	37.0	29.0	11.0	3.0	PVC-FR	Grey (GY)	250 pcs.	633-06078
HV1608		58.0	52.0	44.0	11.0	3.0	PVC-FR	Grey (GY)	250 pcs.	633-06088

All dimensions in mm. Subject to technical changes.



Add items to your watchlist!

www.HT.click/49-387



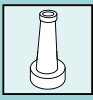

Set for Bend and Edge Protection

HOT Kit

The practical mix of grommets for construction, repairs and home improvement.

Features and benefits

- Flexible and easy to apply
- High resistance to chemicals and environmental influences



HOT Grommet assortment kit.

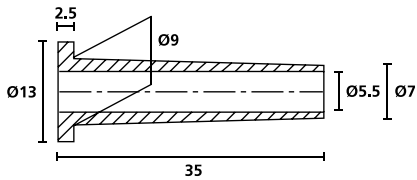

HV2101

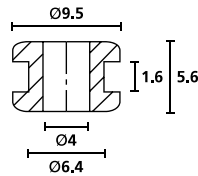

HV1201

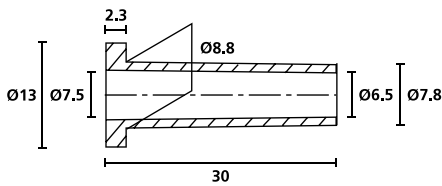

HV2210

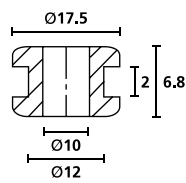

HV1203

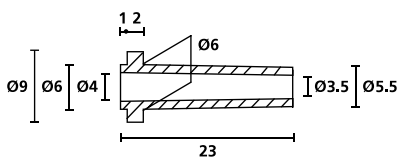

HV2213

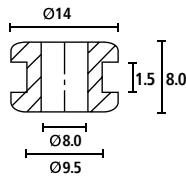

HV1208

Description	Type	Content	Article-No.	Page
Set for Bend and Edge Protection	HOT Kit	-	639-60000	-
Bend Protection Grommets	HV2101	15	632-01010	382
	HV2210	15	632-02100	382
	HV2213	20	632-02130	382
Edge Protection Grommets	HV1201	20	633-02010	386
	HV1203	15	633-02030	386
	HV1208	15	633-02080	386

Minimum Order Quantity (MOQ) may differ from package content.



Even big things have small beginnings.

You have to work with what you've got – and that was exactly what our company founder Paul Hellermann did back in 1935. Inspired by the small rubber tube in bicycle valves, he developed a process for binding electric cables with rubber: the Hellermann grommet and three-pronged pliers. The first two of the hundreds of patents filed since then.

www.HellermannTyton.co.uk/made-for-real

MADE FOR REAL 

