



	Page
Fibre Optic Splice Trays	6-9
Fibre Optic Internal Wall Boxes	10
Fibre Optic Splice Closures	11-20
Closure Accessories	21

Hellacurve™

- Unique curved design
- Compact size for small low fibre count closure
- Optimum fibre bend diameter of 60mm
- 12 entry ports
- Moulded splice holder fins for standard heatshrink (3A) splice protectors
- Used in the FST closure
- Fibre protection tubes secured with cable ties
- For splice capacity see table on page 9
- Overall dimensions 161mm long, 86mm diameter across and 76mm deep



Hellapon™ - Small

- Universal compact size for small closures
- Optimum fibre bend diameter of 60mm
- 2 entry ports and 2 mounting positions for splice inserts
- Accepts various inserts for heatshrink or mechanical splice protectors
- Inserts can also accept PON devices
- Used in the FST and FRBU closures
- Fibre protection tubes secured with cable ties or rubber retainer blocks (Tubefix)
- Supplied with splice retaining strap
- Tray can be mounted either on a fixed support or flexible end mounted hinge
- Back to back mounting capability for routing fibre between two mating trays
- For splice capacity, see table on page 9
- Overall dimensions 158mm x 85mm x 9mm



Hellapon™ - Medium

- Rectangular tray for single element applications
- Optimum fibre bend diameter of 60mm
- 4 entry ports
- Moulded splice holder fin options for heatshrink (3A) and ANT mechanical splice protectors
- Also available without fins for mounting other holder types or devices
- Style A trays are coloured coded, white (3A), yellow (ANT)
- Used in the FRBU, FML, PLC closures and specialist applications
- Tray style A can mounted either on a fixed support or flexible side hinges
- Tray style B has side mounted pivot points
- Fibre protection tubes secured with cable ties
- Supplied with splice retaining strap
- For splice capacity, see table on page 9
- Overall dimensions 235mm x 96mm x 7mm



Style A (ANT shown)



Style B

Hellafos™

- Circular tray for single element applications
- Optimum fibre bend diameter of 60mm
- 4 and 6 entry ports options
- Moulded splice holder fin options for standard heatshrink (3A)
- For splice capacity, see table on page 9
- Also available without fins for mounting other holder types or devices
- Also available in LFH polymer in black
- Used in wallboxes and specialist applications
- Fibre protection tubes secured with cable ties
- Supplied with splice retaining strap
- Overall dimensions 131mm x 152mm x 10mm



With moulded fins



Without fins

Hellipse™ NZDF SE-A

- Elliptical tray for single element and single circuit applications
- Fibre bend diameter of 75mm for NZDF Cables
- Recommended for up to 1625nm bandwidth
- Bend limiting positive fibre management
- 10 entry ports
- Accepts 2 inserts for heatshrink or mechanical splice protectors (for splice capacity, see table on page 9)
- Inserts can also accept PON devices
- Used in FDN, UFC closures and wallboxes
- Fibre protection tubes secured with cable ties or rubber retainer blocks (Tubefix)
- 2 pivot points for mounting into a 6 tray module
- Back to back mounting capability for routing fibre between two mating trays
- Overall dimensions 222mm x 148mm x 7mm



Hellipse™ NZDF SE-B

- Elliptical tray for single element and single circuit applications identical to the SE-A tray but with reduced width
- Fibre bend diameter of 75mm for NZDF Cables
- Recommended for 1625nm bandwidth
- Bend limiting positive fibre management
- 8 entry ports
- Accepts 2 inserts for heatshrink or mechanical splice protectors (for splice capacity, see table on page 9)
- Inserts can also accept PON devices
- Used in FML closure and wallboxes
- Fibre protection tubes secured with cable ties or rubber retainer blocks (Tubefix)
- 2 pivot points for mounting into a 6 tray module
- Back to back mounting capability for routing fibre between two mating trays
- Overall dimensions 184mm x 148mm x 7mm



Hellipse™ NZDF SC-1

- Elliptical tray for single circuit applications
- 3.5mm thick tray allows higher closure capacity compared to other Hellipse™ styles. 12 trays fit into a standard 6 tray module
- Fibre bend diameter of 75mm for NZDF Cables
- Recommended for up to 1625nm bandwidth
- Bend limiting positive fibre management
- 6 entry ports
- Accepts 8 heatshrink (3A) or 8 ANT splice protectors (see table on page 9)
- Used in UFC, FML, FDN closures and wallboxes
- Fibre protection tubes secured with integrally moulded retention features
- Ideally suited in last mile FTTX applications for multiple customer closures
- Overall dimensions 184mm x 148mm x 3.5mm

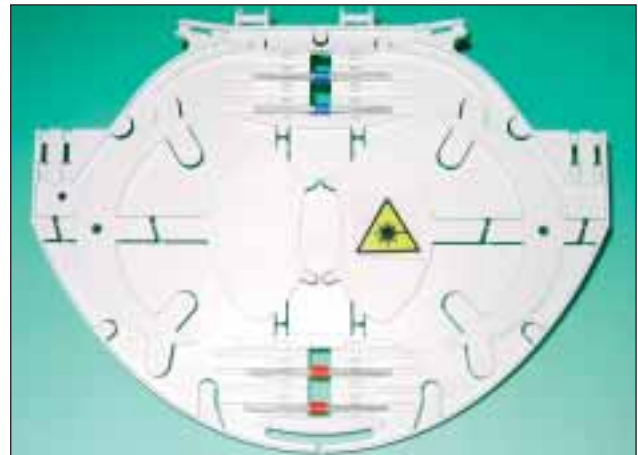

Hellipse™ - SMF

- Elliptical tray for single element applications
- Optimum fibre bend diameter of 60mm
- 12 cable entry ports
- Moulded splice holder fin options for heatshrink (3A)
- For splice capacity, see table on page 9
- Also available without fins for mounting other holder types or devices
- Used in FDN, UFC closures and wallboxes
- Fibre protection tubes secured with cable ties or rubber retainer blocks (Tubefix)
- Has 2 pivot points for mounting into a 6 tray module
- Supplied with splice retaining strap
- Overall dimensions 203mm x 148mm x 7mm



Hellamass™ - Large

- Rectangular double sided tray for high fibre count multiple element and ribbon applications (for ribbon applications consult technical department on +44 (0) 1752 761214)
- Fibre bend diameter of 75mm for NZDF Cables
- 4 wide cable entry ports
- Accepts 24 inserts (12 each side) for heatshrink or mechanical splice protectors (for splice capacity, see table on page 9)
- Inserts can also accept PON devices
- Used in the FML and UFC Closures plus rack mounted applications. Design of tray allows cable entry and exit from the same side as well as fibre route reversal if required
- Storage area on reverse side for excess fibre
- Clear plastic cover plates on both sides
- Single pivot point for mounting onto a flexible hinge
- Fibre protection tubes or cables secured with cable ties
- Removable windows for mounting up to 12 optical connectors
- Overall dimensions 440mm x 145mm x 19mm



Types of splice protector inserts and maximum splices for trays

Splice Protector Inserts							
Tray Type	HS 3A (large) With Band *	4 Fibre Ribbon	HS 6A (Small)		ANT	3M Fibrelok™	12 Fibre Ribbon
			With Band *	Without Band			
Hellacurve™	24	-	-	-	-	-	-
Hellapon™ - Small	12	48	16	18	24	8	-
Hellapon™ - Medium	16	64	16	-	24	-	-
Hellafos™	24	96	-	-	-	-	-
Hellipse™ NZDF SE-A	12	48	16	18	24	8	48
Hellipse™ NZDF SE-B	12	48	16	18	24	8	48
Hellipse™ SC-1	8	-	-	-	8	-	-
Hellipse™ SMF	24	96	-	-	-	-	-
Hellamass™ Large	144	384	192	216	288	96	576

Moulded Splice Fins

3A/PON Insert

6A Insert

ANT Insert

Ribbon Insert

* Splice protector anti-vibration band

Note: for PON device applications please contact our technical department on +44 (0)1752 761214

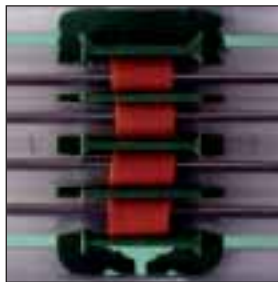

6 Way
3A/PON Insert



9 Way
6A Insert



12 Way
ANT Insert



4 Way
Ribbon Insert

CPU - Customer Premise Unit

The CPU is a low cost compact surface mounted optical distribution box used for the organisation and protection of fibre optic splices in internal environments. Manufactured from either epoxy coated steel or plastic, it contains 1 Hellafos™ splice tray mounted on a cable loop storage spool.

- 2 piece box with integral seal
- Robust construction in PVC
- Contains 1 Hellafos™ splice tray for up to 24 3A heatshrink splice protectors (12 splices maximum recommended)
- Compact and low profile
- Multiple cable entries
- Each kit is supplied with cable glands and cable management materials
- Box complies to IP56 seal rate

Typical application

- The jointing of low fibre count distribution cables in internal and sheltered environments
- For additional details and more kits for plastic box applications please contact our sales office

CPU Dimensions (mm)		
Height	Width	Depth
195	145	80



Plastic CPU

CPU Kits			
UNS No.	Reference	No. of Cable Entries	Position and Gland Size
857-00349	CPU3862	2	2 PG16 glands on same side only
857-00350	CPU3863	4	2 PG11 glands on one side and 2 PG16 glands on the opposite
857-00351	CPU3864	4	2 PG9 glands on one side and 2 PG16 glands on the opposite
857-00352	CPU3865	2	1 PG16 gland on one side and 1 PG9 for 4x Pigtails on the opposite

BFP - Building Flexibility Point

The BFP is a 48 fibre capacity wall mounted box used for the organisation and protection of fibre optic cable splices. The main application is in internal environments such as office complexes where an external cable is to be joined to internal cables using fibre optic splices. Manufactured from epoxy coated steel, the box contains 4 Hellafos™ splice trays mounted on a hinged plate for access to a fibre storage basket.

- Aesthetic design with rounded edges
- Robust construction in rust proofed steel
- Contains 4 Hellafos™ splice tray for up to 96 3A heatshrink splice protectors (48 splices maximum recommended)
- Single hinged door fitted with 2 quarter turn chrome plated key locks
- Integral back plate with cable strength member anchor points
- Fibre storage area behind hinged splice tray mounting plate
- Cable entries at top and bottom
- Range of bulkhead gland plates available for various cable entries
- Supplied with cable management materials

Typical Applications

The splicing and distribution of external cables to internal cables within buildings without the use of connectors thereby reducing optical losses and cost of installation.

Note: Glands and bulkhead plates for cable entry must be ordered separately to suit application.

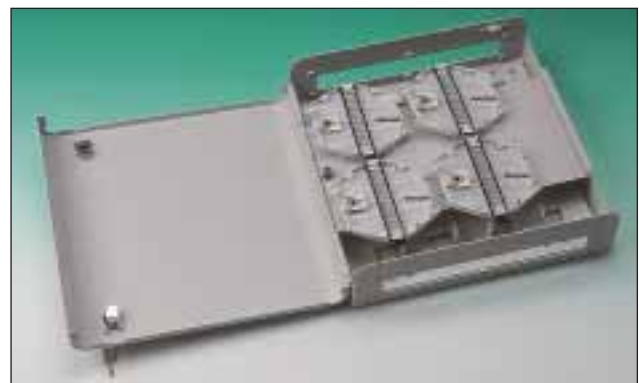

BFP1019C

BFP Dimensions (mm)		
Height	Width	Depth
350	350	128

BFP - Building Flexibility Point			
UNS No.	Reference	Cable Entries and Gland Type	Number of Trays
857-00009	BFP1019C	See table below	4

BFP Bulkhead Plate Selection Chart		
UNS No.	Reference	Gland type and Number Kit
857-00012	BFP1022C	Blank plate
857-00013	BFP1024	2 PG16 glands and 2 PG16 blanking plugs
857-00017	BFP1840	2 PG21 glands and 2 PG21 blanking plugs
857-00018	BFP3643	2 M25 glands and 2 M25 blanking plugs

FST - Fibre Small Tray

The FST is a compact cap-ended ready access closure used for the organisation and protection of fibre optic cable splices in aerial, underground and directly buried installations.

It is available with 3 base configurations having 3, 10 or 12 round cable ports and an oval port for loop through applications. The closure cover is environmentally sealed to the base using a rolling "O" ring whilst the cables are sealed using either heatshrink sleeving or Cablelok™ non-heatshrink seals (see page 32) depending on the base configuration selected.

Each base configuration can be supplied with a single Hellacurve™ curved tray or multiple Hellapon™ - Small trays.

Hellapon™ - Small tray versions can be supplied with up to 3 Hellapon™ - Small trays. 2 trays are mounted back to back, the 3rd tray is mounted on a flexible hinge for easy access. FST's may also be supplied with 1 fixed Hellapon™ - Small Tray and a fibre storage basket for loop through applications.

- Maximum 36 fibre capacity using standard heatshrink splice protectors
- Small trays giving compact size closures
- Mounting plate for connectorised cables and pigtails on the Hellacurve™ tray
- Base to cover clamp with quick release Snapperband™ or stainless steel latch clamp
- Cablelok™ FST's can be supplied with a variety of Cablelok™ sizes to suit the base configuration (see page 32 for cable range)
- Heatshrink kits are supplied with 1 sleeve and branch clip for the oval port and 2 sleeves for the B ports
- Supplied with cable surface preparation, management and identification materials
- Other options and spur cable sealing kits available, please contact our sales office

Typical Applications

FST with the Hellacurve™ Tray

- Splicing low fibre count cables in CCTV, trunk and campus (between buildings) networks

FST with the Hellapon™ - Small Tray

- Splicing low fibre count distribution cables in fibre to the home (FTTH), fibre to the kerb (FTTK) and CATV

Accessories

- Port opening tools TPC1940, TPC1941, TPC1942 and TPC3337 (see page 35)
- Pole or wall mounting bracket kit ACC1037 (see page 13)
- Cover release tool TCR1726 (see page 35)



4 Way Hellacurve™ Pigtail Connector Plate

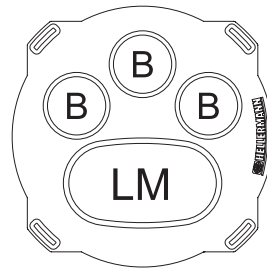

4 port Base
(Heatshrink & Cablelok™)

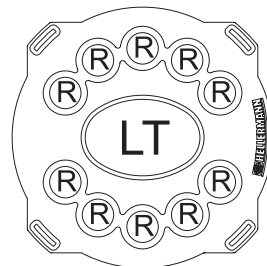

11 Port Base
(Heatshrink & Cablelok™)

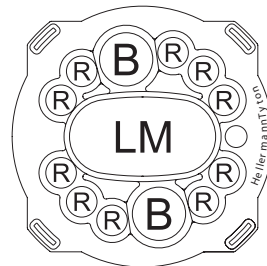

13 Port Base
(Cablelok™ only)



FST with 4 port base & Hellacurve™ tray



FST with 13 port base, Hellapon™ - Small Tray & storage basket

FST Dimensions (mm)	
Length	Diameter
310	110

FST Part & Cable Details			
Port	No. of Ports	Cable Range (mm)	
		Cablelok™	Heatshrink
LM	1	2 x 9.5 - 22.0	2 x 8.0 - 22.0
LT	1	Not applicable	2 x 8.0 - 15.0
B	2 or 3	4.8 - 16.5	6.0 - 19.0
R	10	1.7 - 9.5	Not applicable

FST Kits					
UNS No.	Reference	No. of Ports	No. of Trays	Type of Tray	Method of Sealing
857-00166	FST1754	4	1	Hellacurve™	Cablelok™
857-00169	FST1845	4	1	Hellacurve™	Heatshrink
857-00168	FST1844	11	1	Hellacurve™	Cablelok™
857-00179	FST3577	13	2	Hellapon™ - Small	Cablelok™
857-00180	FST3578	13	3	Hellapon™ - Small	Cablelok™
857-00181	FST3697	4	2	Hellapon™ - Small	Cablelok™
857-00182	FST3705	4	2	Hellapon™ - Small	Heatshrink
857-00195	FST3803*	11	1	Hellapon™ - Small	Cablelok™ & Heatshrink**
857-00196	FST3804*	13	1	Hellapon™ - Small	Cablelok™

* Closure is fitted with fibre loop storage basket

** Includes heatshrink for LT oval port

FRBU - Fibre Residential and Business Unit

The FRBU is a cap-ended ready access closure of compact size used for the organisation and protection of fibre optic cable splices in aerial, underground and direct buried installations.

It is available with 2 base configurations having 8 or 10 round cable ports and an oval port for loop through applications. The closure cover is fitted with a pressure release valve and is environmentally sealed to the base using a rolling "O" ring. Cables are sealed using either heatshrink sleeving or Cablelok™ non-heatshrink seals (see page 32).

The FRBU can be supplied with 2 tray options. 2 to 6 Hellapon™ - Medium trays are mounted on a central rigid support. The trays can be stacked (short cover) or with 2 side hinges (long cover). Alternatively 6 Hellapon™ - Small trays mounted on flexible end hinges (short cover) are available.

- Maximum 96 fibre (72 fibre recommended) capacity using standard heatshrink splice protectors
- Approvals from PTT's worldwide
- Hellapon™ - Medium trays have integral splice fins
- Hellapon™ - Small trays giving compact size closures with interchangeable inserts for various types of splices (see page 9)
- Base to cover clamp with quick release Snapperband™ or stainless steel latch clamp
- The heatshrink kits are supplied with 1 sleeve and branch clip for the oval port and 2 sleeves for the round ports
- Cablelok™ kits are supplied with 1 off each R1, R2, R3 and 2 off B2 Cableloks™. 9 port Hellapon™ - Medium tray kits also have 1 off L1 Cablelok™
- The kits are also supplied with cable surface preparation, management and identification materials
- For kit options not listed or spur cable sealing kits, please contact our Sales Office

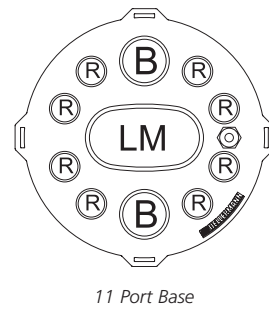
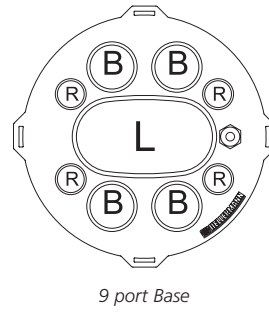

Hinged FRBU with Hellapon™ - Medium trays



Stacked FRBU with Hellapon™ - Medium trays



FRBU Dimensions (mm)

Type	Length	Diameter
Hellapon™ - Medium Side Hinged	505	130
Hellapon™ - Medium Stacked	435	130
Hellapon™ - Small Flexible Hinged	435	130

FRBU Port & Cable Details

Port	No. of Ports	Cable Range (mm)	
		Cablelok™	Heatshrink
L	1	2 x 13.0 - 22.0	2 x 12.0 - 24.0
LM	1	2 x 9.5 - 22.0	2 x 8.0 - 22.0
B	2 or 4	4.8 - 16.5	6.0 - 19.0
R	4 or 8	1.7 - 9.5	4.0 - 11.0

Typical Applications

Hinged FRBU with Hellapon™ - Medium Tray

- Splicing low to medium fibre count distribution cables in trunk, fibre to the kerb (FTTK) and CATV networks

Stacked FRBU with Hellapon™ - Medium Tray

- For network maintenance and repair
- CCTV installations - multiple cable entries and drops

FRBU with Hellapon™ - Small Tray

- Splicing medium fibre count cables in trunk networks

Accessories

- Port opening tools TPC1939, TPC1940 and TPC3337 (see page 35)
- Pole or wall mounting bracket kit ACC1037 (see below)
- Cover release tool TCR1726 (see page 35)
- Additional Hellapon™ - Medium Tray kit ACC1341 (UNS 857-40003)



FRBU with Hellapon™ - Medium trays and loop storage basket

Hinged FRBU with Hellapon™ - Medium Trays					
UNS No.	Reference	No. of Ports	No. of Trays	Type of Tray	Method of Sealing
857-00138	FRBU2565	9	6	Hellapon™ - Medium	Cablelok™
857-00132	FRBU2372	9	6	Hellapon™ - Medium	Heatshrink
857-00164	FRBU3771*	9	3	Hellapon™ - Medium	Cablelok™
857-00165	FRBU3772*	9	3	Hellapon™ - Medium	Heatshrink

*Closure is fitted with fibre loop storage basket

Stacked FRBU with Hellapon™ - Medium Trays					
UNS No.	Reference	No. of Ports	No. of Trays	Type of Tray	Method of Sealing
857-00103	FRBU1313	9	2	Hellapon™ - Medium	Heatshrink
857-00104	FRBU1314	9	4	Hellapon™ - Medium	Heatshrink
857-00105	FRBU1315	9	6	Hellapon™ - Medium	Heatshrink
857-00113	FRBU1323	9	2	Hellapon™ - Medium	Cablelok™
857-00114	FRBU1324	9	4	Hellapon™ - Medium	Cablelok™
857-00115	FRBU1325	9	6	Hellapon™ - Medium	Cablelok™
857-00100	FRBU1310	11	2	Hellapon™ - Medium	Heatshrink
857-00101	FRBU1311	11	4	Hellapon™ - Medium	Heatshrink
857-00102	FRBU1312	11	6	Hellapon™ - Medium	Heatshrink
857-00110	FRBU1320	11	2	Hellapon™ - Medium	Cablelok™
857-00111	FRBU1321	11	4	Hellapon™ - Medium	Cablelok™
857-00112	FRBU1322	11	6	Hellapon™ - Medium	Cablelok™



FRBU with Hellapon™ - Small trays

FRBU with Hellapon™ - Small Trays					
UNS No.	Reference	No. of Ports	No. of Trays	Type of Tray	Method of Sealing
857-00155	FRBU3579	9	6	Hellapon™ - Small	Cablelok™
857-00156	FRBU3580	9	6	Hellapon™ - Small	Heatshrink



FRBU/FST Mounting Bracket ACC1037 (UNS 857-40000)

FDN – Fibre Distribution Node

The FDN is a medium size oval shaped cap-ended ready access closure. Primarily used in FTTH networks for the organisation, protection and distribution of fibre optic cable splices in aerial, underground and directly buried installations.

It is available with a single base configuration having 58 round cable ports and an oval port for loop through applications.

The closure cover which is fitted with a pressure relief valve is environmentally sealed to the base using an "O" ring and quick release clamp. The cables are sealed using either heatshrink sleeving (with the exception of the R ports) or Cablelok™ non-heatshrink seals on all ports.

The FDN is supplied with either 12 Hellipse™ SE-A trays, 24 Hellipse™ SC-1 trays or 12 Hellipse™ SMF trays in two tray retaining modules mounted on a fixed support.

- Maximum 144 fibre capacity using standard heatshrink splice protectors
- Hellipse™ SE-A trays have interchangeable snap-in inserts for various types of splices (see page 9)
- Hellipse™ SMF trays have moulded fins (see page 9)
- Quick release base to cover clamp
- Cablelok™ only kits contain 2 off each of R1, R2, R3, B1 and S2 Cableloks™
- Cablelok™ and heatshrink kits contain 2 off each R1, R2 and R3 Cableloks™ Plus 4 off heatshrink sleeves for the round ports and the oval port
- The kits are also supplied with cable preparation and identification materials
- For kit options not listed or spur cable sealing kits, please contact our Sales Office

Typical Applications

- Fibre to the home (FTTH) with multiple cable entries for customer connections
- Installation in narrow foot way boxes where space is limited
- Blown fibre/cable installations
- For ribbon or Hellipse NZDF SC-1 single circuit applications please contact our sales office

Accessories

- Port opening tools TPC1941, TPC1942, TPC1943 and TPC3337 (see page 35)
- Wall mounting bracket FDNA3763 (UNS 857-40078)
- Stainless steel wall mounting strap kit ACC3334 (UNS 857-40042)
- FDN installation clamp FDNA3717 (see page 34)
- Loop through basket kit FDNA3764 (UNS 857-40079)



Blown cable FTTH application

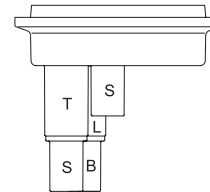
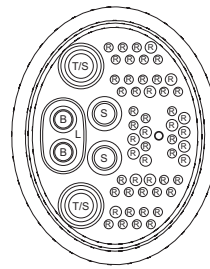

FDN with Hellipse™ NZDF SE-A trays

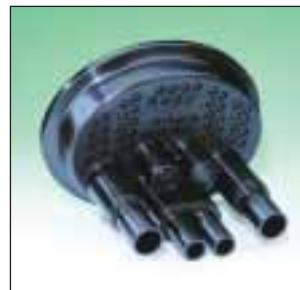

FDN base configuration



FDN with fibre storage basket



Wall Mounting Bracket

FDN Dimensions (mm)	
Length	Width
455	312/222

FDN Port & Cable Details			
Port	No. of Ports	Cable Range (mm)	
		Cablelok™	Heatshrink
L	1	2 x 13.0 - 22.0	2 x 12.0 - 24.0
T	2	15.5 - 29.0	12.0 - 35.0
S	4	5.0 - 20	6.0 - 26.0
B	2	4.8 - 16.5	6.0 - 19.0
R	52	1.7 - 9.5	-

FDN Kits				
UNS No.	Reference	No. of Trays	Type of Tray	Method of Sealing
857-00042	FDN3583	12	Hellipse™ NZDF SE-A	Cablelok™
857-00043	FDN3584	12	Hellipse™ NZDF SE-A	Cablelok™ & Heatshrink
857-00044	FDN3585	12	Hellipse™ SMF	Cablelok™
857-00045	FDN3586	12	Hellipse™ SMF	Cablelok™ & Heatshrink

PLC - Power Line Closure

The PLC is a stainless steel closure used for the organisation and protection of fibre optic cable splices principally in aerial installations on power line pylons. The PLC is supplied with 8 Hellapon™ - Medium trays pivoted on angled supports

The 2 halves of the stainless steel closure are sealed with a high performance gasket and clamping screws whilst polymeric insulated cables are sealed with either Cablelok™ non-heatshrink seals or heatshrink sleeving. OPGW cables are anchored and sealed to the PLC casing with dedicated stainless steel clamp glands.

- Maximum 128 fibre (96 fibre recommended) capacity using standard heatshrink splice protectors
- Manufactured from 1.2mm thick high grade stainless steel
- Suitable for use with OPGW, ADSS and Wrap cables
- Supplied with either 2, 3 or 4 holes at one end for the mounting of cable glands
- Customised cable entry positions available on request for inline applications
- Shotgun proof
- Integral mounting brackets
- Gland kits for ADSS and Wrap cables contain both heatshrink and non-heatshrink Cablelok™ seals
- Blanking plugs are available for unused gland holes
- Supplied with cable surface preparation, management and identification materials

Typical Applications

- The jointing of fibre optic cables on trunk routes carried on overhead power lines
- Low fire hazard installations such as railway tunnels
- Harsh environments

Accessories

- Tower mounting bracket kit PLCA1721 (UNS 857-40161)
- Lockable security frame kit PLCA3762 (UNS 857-40169)

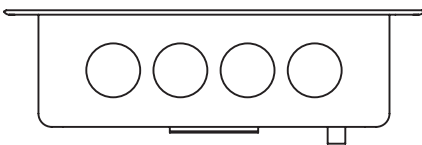

Maximum of 4 holes 31mm dia. for cable glands or blanking plugs

PLC Dimensions (mm)		
Length	Width	Depth
515	240	135

PLC Kits			
UNS No.	Reference	Number of Cable Entries	Number of Trays
857-00221	PLC3367	2	8
857-00222	PLC3368	3	8
857-00223	PLC3369	4	8

Gland Kits for ADSS & Wrap Cables			
UNS No.	Reference	Cable Range (mm)	Cablelok™ Seals Supplied
857-40162	PLCA2096	5.2 - 9.5	1 off each R2 and R3
857-40163	PLCA2097	8.0 - 16.5	1 off each B2 and B3
857-40164	PLCA2098	12.0 - 20.0	1 off each S2 and S3

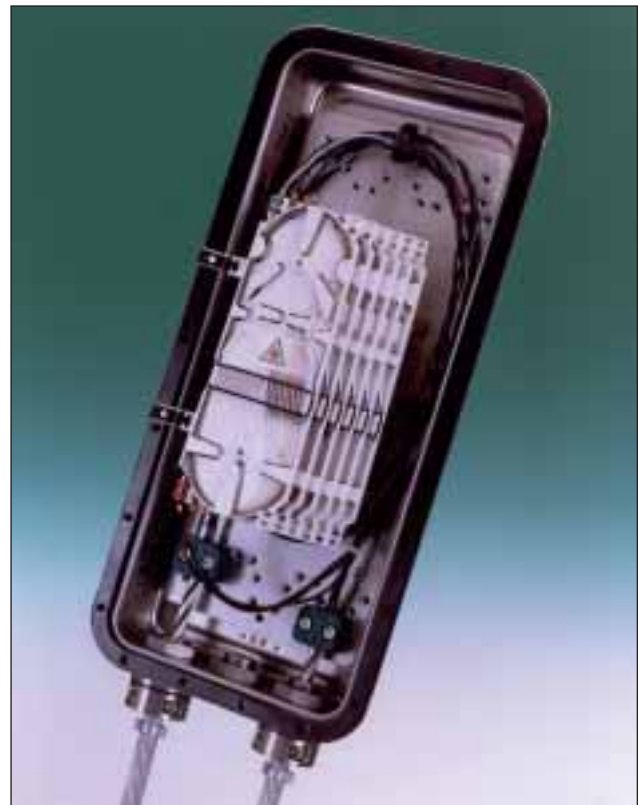

PLC with 8 Hellapon™ - medium trays



PLC sealing glands - available seperately (see below)

Gland Kits for OPGW Cable		
UNS No.	Reference	Cable Diameter (mm)
857-40157	PLCA1637	12.7
857-40158	PLCA1638	14.1
857-40168	PLCA2326	14.5
857-40159	PLCA1639	16.1
857-40160	PLCA1640	18.8
857-40165	PLCA2099	20.0
857-40166	PLCA2100	25.4
857-40167	PLCA2197	Blanking Plug

Note: The PLC closure is supplied without any sealing glands, which must be ordered separately

Note: Glands for other sizes of OPGW cable can be designed to customer requirements

FML - Fibre Modular Link

The FML is a medium to large cap ended ready access closure used for the organisation and protection of fibre optic cable splices in aerial, underground and direct buried installations. The base configuration features 12 round ports and an oval port for loop through applications. The cover, which is fitted with a pressure test valve, is available in 4 different lengths depending on the number and type of tray selected. The cover is environmentally sealed to the base using an "O" ring and base to cover clamp whilst the cables are sealed using either heatshrink sleeving or Cablelok™ non-heatshrink seals. The FML can be supplied with the following tray options:

- 6, 12, 18 or 24 Hellipse™ NZDF SE-B trays
- 12 Hellapon™ - Medium trays
- 12, 24, 36, or 48 Hellipse™ NZDF SC-1 trays
- 2 Hellamass™ - Large trays

Choice of tray will depend on capacity, whether or not interchangeable splice inserts are required, number of tray entries and type of cable and fibre selected.

- Maximum 288 fibre capacity using standard heatshrink splice protectors
- Quick release base to cover clamp
- The kits with heatshrink sealing materials are supplied with 2 sleeves for the S or B ports, 1 sleeve for the T ports and 1 sleeve and branch clip for the oval port
- If Cablelok™ seals are required as an alternative to heatshrink sleeving, these must be ordered separately (see page 32 for details)
- Supplied with cable surface preparation, management and identification materials
- For additional spur cable sealing kits, please contact our Sales Office



FML base configuration



Strength member anchor plates



FML with Hellipse™ - NZDF SE-B trays



FML with Hellapon™ - medium trays



FML with Hellamass™ - large trays



FML showing Hellapon™ - medium tray storage basket

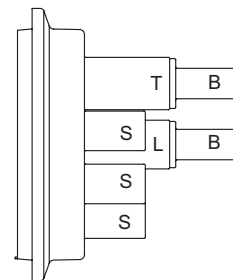
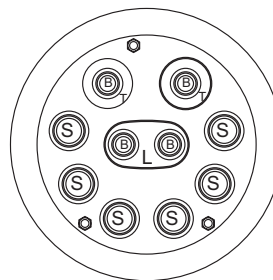

FML Port & Cable Details			
Port	No. of Ports	Cable Range (mm)	
		Cablelok™	Heatshrink
L	1	2 x 13.0 - 22.0	2 x 12.0 - 24.0
T	2	15.5 - 29.0	12.0 - 35.0
S	6	5.0 - 20.0	6.0 - 26.0
B	4	4.8 - 16.5	6.0 - 19.0

FML with Hellipse™ NZDF SE-B and NZDF SC-1 Trays

Splicing in primary rings in metropolitan area networks for both single element and single circuit. For Hellipse NZDF SC-1 single circuit applications please contact our sales office.

FML with Hellapon™ - Medium Trays

Splicing multiple elements in long distance trunk networks with loop storage option

FML with Hellamass™- Large Trays

Splicing high fibre count ribbon cables in super highway primary rings within metropolitan area networks.

Note: For ribbon applications please contact the technical department on +44 (0) 1752 761214.

Accessories

- Port opening tools TPC1942, TPC1943 and TPC3337 (see page 35)
- Wall mounting bracket FMLA3279 (UNS 857-40106)
- Stainless steel wall mounting strap kit ACC3334 (UNS 857-40042)
- Installation clamp for FML UFCA2685 (see page 34)

FML Dimensions (mm)

Cover Reference	Closure Width	Closure Length
A	D1 = 220 D2 = 275	400
B	D1 = 220 D2 = 275	600
BC	D1 = 220 D2 = 275	670
C	D1 = 220 D2 = 275	750

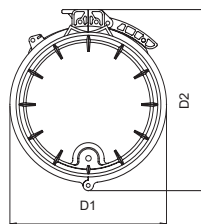

FML Hellipse™ - NZDF SE-B Trays

UNS No.	Reference	No. of Trays	Type of Tray	Method of Sealing	Cover
857-00067	FML3079	6	Hellipse™ NZDF SE-B	Cablelok™*	A
857-00068	FML3080	12	Hellipse™ NZDF SE-B	Cablelok™*	B
857-00069	FML3081	18	Hellipse™ NZDF SE-B	Cablelok™*	B
857-00070	FML3082	24	Hellipse™ NZDF SE-B	Cablelok™*	B
857-00061	FML3073	6	Hellipse™ NZDF SE-B	Heatshrink	A
857-00062	FML3074	12	Hellipse™ NZDF SE-B	Heatshrink	B
857-00063	FML3075	18	Hellipse™ NZDF SE-B	Heatshrink	B
857-00064	FML3076	24	Hellipse™ NZDF SE-B	Heatshrink	B

FML Hellapon™ - Medium Trays

UNS No.	Reference	No. of Trays	Type of Tray	Method of Sealing	Cover
857-00055	FML3005	12	Hellapon™ - Medium	Cablelok™*	B
857-00054	FML3004	12	Hellapon™ - Medium	Heatshrink	B

FML Hellamass™ - Large Trays

UNS No.	Reference	No. of Trays	Type of Tray	Method of Sealing	Cover
857-00092	FML3775	2	Hellamass™ - Large	Cablelok™*	C
857-00093	FML3777	2	Hellamass™ - Large	Heatshrink	C

* Cablelok™ seals for these kits have to be purchased separately



Wall mounting bracket



Range of cover sizes

UFC – Universal Fibre Closure

The UFC is a high fibre capacity cap ended ready access closure used for the organisation and protection of fibre optic cable splices in aerial, underground and direct buried installations. It is available with a single base configuration having 28 round ports and 2 oval ports for loop through applications. The cover is fitted with a pressure test valve and is available in 4 different lengths depending on the number and type of tray selected. The cover is environmentally sealed to the base using an "O" ring and base to cover clamp whilst the cables are sealed using either heatshrink sleeving or Cablelok™ non-heatshrink seals.

The UFC can be supplied with the following tray options:

- 6, 12, 18, 24 or 36 Hellipse™ NZDF SE-A trays
- 6, 12, 18, 24 or 36 Hellipse™ SMF trays
- 12, 24, 36, 48 or 72 Hellipse™ NZDF SC-1 trays
- 4 Hellamass™ - Large trays (other quantities available upon request)

The choice of tray will depend on capacity, whether or not interchangeable splice inserts are required, number of tray entries and type of cable and fibre selected.

- Maximum 384 fibre capacity using standard heatshrink splice protectors (NZDF SE-A trays)
- Quick release base to cover clamp
- Kits with heatshrink sealing materials are supplied with 2 sleeves for the S or B ports, 1 sleeve for the T ports and 1 sleeve and branch clip for the oval ports
- If Cablelok™ seals are required as alternative to heatshrink sleeving, these must be ordered separately (see page 32 for details)
- All Hellipse™ tray UFC's are fitted with loop storage baskets
- Supplied with cable surface preparation, management and identification materials
- For additional spur kits, please contact our Sales Office



UFC with Hellipse™ NZDF SE-A trays



UFC with Hellipse™ SMF trays



UFC with Hellamass™ large trays and storage basket

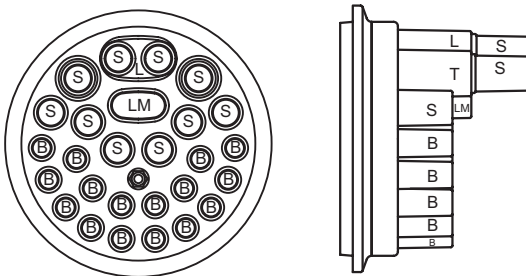

UFC Port & Cable Details			
Port	No. of Ports	Cable Range (mm)	
		Cablelok™	Heatshrink
L	1	2 x 13.0 - 22.0	2 x 12.0 - 24.0
LM	1	2 x 9.5 - 22.0	2 x 8.0 - 22.0
T	2	15.5 - 29.0	12.0 - 35.0
S	10	5.0 - 20.0	6.0 - 26.0
B	16	4.8 - 16.5	6.0 - 19.0



UFC base configuration

UFC with Hellipse™ NZDF SE-A, NZDF SC-1 and SMF Trays

Splicing in primary rings in metropolitan area networks for both single circuit and single element. For Hellipse NZDF SC-1, single circuit applications please contact our sales office.

UFC with Hellamass™ - Large Trays

Splicing high fibre count ribbon cables in super highway primary rings within metropolitan area networks

Accessories

- Port opening tools TPC1942, TPC1943 and TPC3337 (page 35)
- Wall mounting bracket UFCA2564 (UNS 857-40180)
- Stainless steel wall mounting strap Kit ACC3334 (UNS 857-40042)
- UFC Installation clamp UFCA2685 (see page 34)

UFC Dimensions (mm)

Cover Reference	Closure Width	Closure Length
A	D1 = 275 D2 = 310	400
B	D1 = 275 D2 = 310	550
BC	D1 = 275 D2 = 310	600
C	D1 = 275 D2 = 310	750

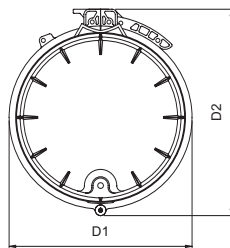

UFC with Hellipse™ - NZDF SE-A Trays

UNS No.	Reference	No. of Trays	Type of Tray	Method of Sealing	Cover
857-00252	UFC2794	6	Hellipse™ - NZDF SE-A	Cablelok™	A
857-00269	UFC2868	12	Hellipse™ - NZDF SE-A	Cablelok™	BC
857-00270	UFC2869	18	Hellipse™ - NZDF SE-A	Cablelok™	C
857-00271	UFC2870	24	Hellipse™ - NZDF SE-A	Cablelok™	C
857-00272	UFC2871	30	Hellipse™ - NZDF SE-A	Cablelok™	C
857-00273	UFC2872	36	Hellipse™ - NZDF SE-A	Cablelok™	C
857-00247	UFC2770	6	Hellipse™ - NZDF SE-A	Heatshrink	A
857-00264	UFC2844	12	Hellipse™ - NZDF SE-A	Heatshrink	BC
857-00265	UFC2845	18	Hellipse™ - NZDF SE-A	Heatshrink	C
857-00266	UFC2846	24	Hellipse™ - NZDF SE-A	Heatshrink	C
857-00267	UFC2847	30	Hellipse™ - NZDF SE-A	Heatshrink	C
857-00268	UFC2848	36	Hellipse™ - NZDF SE-A	Heatshrink	C

UFC with Hellamass™ - Large Trays

UNS No.	Reference	No. of Trays	Type of Tray	Method of Sealing	Cover
857-00316	UFC3779	4	Hellamass™ - Large	Cablelok™	C
857-00317	UFC3780**	4	Hellamass™ - Large	Cablelok™	C
857-00318	UFC3781	4	Hellamass™ - Large	Heatshrink	C
857-00319	UFC3782**	4	Hellamass™ - Large	Heatshrink	C

*Cablelok™ seals for these kits have to be purchased separately
 **Hellamass™ UFC fitted with fibre loop storage basket

UFC with Hellipse™ - SMF Trays

UNS No.	Reference	No. of Trays	Type of Tray	Method of Sealing	Cover
857-00328	UFC2837	6	Hellipse™ SMF	Cablelok™	BC
857-00329	UFC2838	12	Hellipse™ SMF	Cablelok™	BC
857-00262	UFC2839	18	Hellipse™ SMF	Cablelok™	C
857-00330	UFC2840	24	Hellipse™ SMF	Cablelok™	C
857-00331	UFC2841	30	Hellipse™ SMF	Cablelok™	C
857-00332	UFC2842	36	Hellipse™ SMF	Cablelok™	C
857-00333	UFC2831	6	Hellipse™ SMF	Heatshrink	BC
857-00260	UFC2832	12	Hellipse™ SMF	Heatshrink	BC
857-00334	UFC2833	18	Hellipse™ SMF	Heatshrink	C
857-00261	UFC2834	24	Hellipse™ SMF	Heatshrink	C
857-00335	UFC2835	30	Hellipse™ SMF	Heatshrink	C
857-00336	UFC2836	36	Hellipse™ SMF	Heatshrink	C



Wall mounting bracket



Range of cover sizes

BFJ - Blown Fibre Joint

The BFJ is a ready access pan type closure for use as a straight through joint, a customer drop point or a centre blow point for blown fibre underground networks. The closure consists of a circular body with 4 sets of 3 sealed inlets at right angles to each other around its circumference. The closure can be supplied with an integral moulded base and separate cover that is sealed to the body using an "O" ring and stainless clamp (BFJ2244) or with a separate base and cover both of which are sealed to the body by "O" rings and clamps (BFJ2131). An expansion kit (BFJA2312) consisting of the body, "O" ring and clamp is also available so that bodies can be stacked and sealed to each other if cable duct tube entry points in manholes are at different levels.

The BFJ kits are supplied with 4 yellow tube holders which are mounted around the inside of the closure and used for the routing of 5mm diameter blown fibre mini-duct tubes or cable. The outer jacket of the mini-duct tube bundles or cables are sealed into the entry ports using either 'B' series Cablelok™ non-heatshrink seals or heatshrink sleeving. The maximum diameter of duct or cable that the ports can accept being 50mm with heatshrink and 16.5mm with Cablelok™ (see page 32 for details).

An in-line mid span cast aluminium interceptor kit (BFJ2132) is also available for gaining access to duct tubes for a customer drop without disturbing unbroken duct tubes which are already populated with fibre. The circular BFJ is clamped on top of the mid span interceptor kit and the mini-duct tube bundle or cable secured using rubber sealing clamps, of which various sizes are available.

- Modular design that can be expanded in the field
- Multi-port base configuration
- Cover supplied with 5 psi (35 Kpa) pressure relief valve
- Large internal bend diameter (300mm) for long distance blowing of fibres
- Duct and cable sealing with either Cablelok™ or heatshrink sleeving
- All closure kits are supplied with stainless steel clamps, "O" rings and 4 pre-fitted duct tube organisers

Typical Applications

- Trunk routes
- Metropolitan networks (MAN)
- Wide area networks (WAN)
- Fibre to the home (FTTH)

Accessories

- Single heatshrink sleeve kit plus preparation materials BFJ2133 (UNS 857-00002)
- 15mm diameter seal kit for the interceptor kit BFJ2296 (UNS 857-00007)
- 18mm diameter seal kit for the interceptor kit BFJ2179 (UNS 857-00003)
- 30mm diameter seal kit for the interceptor kit BFJ2180 (UNS 857-00004)

BFJ Closure Kits		
UNS No.	Reference	Description
857-00000	BFJ2131	Closure body with top and bottom covers
857-00001	BFJ2132	Mid span interceptor kit (in-line)
857-00006	BFJ2244	Closure body with integral base and top cover*
857-40064	BFJA2312	Closure expansion kit

Note: Cablelok™ non-heatshrink seals can be purchased separately (see page 32 for details).

*BFJ2132 cannot be fitted to BFJ2244



BFJ2244



Internal view of BFJ2244



BFJ2131 mid-span interceptor kit



BFJ Dimensions (mm)			
D1	D2	Internal Diameter	Height
335	424	300	238

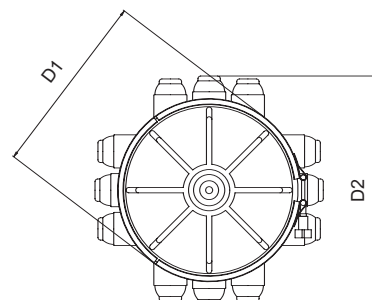

Manifolds

A fibre manifold is a device for dividing and managing fibres within a splice closure or an optical distribution frame. It consists of a moulded divider with snap on cover with 1 or 2 polyethylene tubes inserted at one end and a number of similar tubes at the other. The input tubes are simply fitted over a fibre cable element or loose tube and the group of fibres is then divided into the required number per output tube for routing to the splice area.

- Snap fit construction
- Small and compact
- Removable tubes
- Supplied with identification sleeves
- Suitable for most types of cable construction



4 way manifold

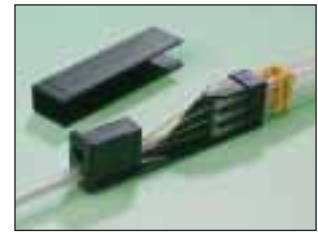

6 way manifold

Manifolds		Inlet tubes			Outlet Tubes			Manifold Dimensions	
UNS No.	Reference	No. of Inlets	Bore Dia (mm)	Length (mm)	No. of Outlets	Bore Dia. (mm)	Length (mm)	WxH (mm)	Length (mm)
857-40085	FM2036	1	4	75	4	3	1000	9.0x9.0	35.5
857-40086	FM2092	1	4	1000	4	3	1500	9.0x9.0	35.5
857-40088	FM2465	2	4	1000	6	3	1500	9.0x14.0	55
875-40105	FM3747	2	3	1000	6	3	1500	9.0x14.0	55

Adapters

The application of an adapter is similar to a manifold except that it is fitted directly over the cable sheath (upto 15mm outside diameter) with the unit tubes or groups of fibres being fed through flexible tubing or wrapped with spiral cut tubing for loop through applications. All kits are supplied with both types of tubing, cable ties and markers.



6, 12, 24 way adapters

Adapters			
UNS No.	Reference	No. of Outlets	Bore Dia (mm)
857-40101	FM3620	6	4
857-40102	FM3621	12	3.25
857-40103	FM3622	24	3.25

Splice Protectors

Fibre splice protectors consist of a heatshrinkable sleeve containing an inner liner of hot meltable adhesive and a stainless steel re-inforcing rod. Specifically designed for the mechanical and environmental protection of fused fibre optic cable splices.

- Available in lengths of 25, 35, 45 and 60mm
- Supplied in either 3A or 6A sizes
- Available in 12 colours and natural transparent
- Fitted with a rubber sleeve for dampening of vibration
- Available for up to 12 fibre ribbon cable incorporating a ceramic re-inforcing member

Splice Protectors					
UNS No.	Reference	Pack Qty.	Type	Length (mm)	Colours
857-40120	FSP650	80	3A	35	Natural
857-40127	FSP738	80	3A	45	Natural
857-40129	FSP758	80	3A	45	10 Colours
857-40112	FSP1242	100	3A	60	Natural
857-40114	FSP1279	80	3A	60	8 Colours
857-40118	FSP3563	80	6A	25	Natural
857-40119	FSP3564	80	6A	40	Natural
857-40130	FSP770	100	Ribbon	40	Natural



Splice Protector Colour Range	
No. of Colours	Colours
8	Brown, red, orange, yellow, green, blue, violet and grey
10	Black, brown, red, orange, yellow, green, blue, violet, grey and white